

# TOSHIBA

TOSHIBA Bar Code Printer

## B-SA4T Series

### Key Operation Specification

|                |   |                   |
|----------------|---|-------------------|
| First Edition  | : | February 21, 2005 |
| Second Edition | : | April 20, 2005    |
| Third Edition  | : | March 29, 2006    |
| Forth Edition  | : | June 30, 2006     |
| Fifth Edition  | : | October 10, 2007  |
| Sixth Edition  | : | February 14, 2008 |

**TOSHIBA TEC CORPORATION**

# TABLE OF CONTENTS

|  | Page     |
|--|----------|
| <b>1. SCOPE</b> .....  | <b>1</b> |
| <b>2. OUTLINE</b> .....  | <b>1</b> |
| <b>3. OPERATION PANEL</b> .....                                    | <b>1</b> |
| <b>4. KEY OPERATION FLOW</b> .....                                 | <b>2</b> |
| <b>5. ONLINE MODE</b> .....  | <b>3</b> |
| 5.1 KEY FUNCTIONS .....  | 3        |
| 5.2 LED FUNCTIONS.....   | 3        |
| 5.3 LCD FUNCTIONS .....  | 3        |
| 5.4 ONLINE MODE OPERATION EXAMPLE .....                            | 4        |
| 5.5 THRESHOLD SETTING.....   | 5        |
| 5.5.1 Outline of Threshold Setting .....                           | 5        |
| 5.5.2 Threshold Setting Operation Example.....                     | 5        |
| 5.6 RESET.....   | 7        |
| 5.7 PARAMETER SETTING.....   | 8        |
| 5.7.1 Parameter Setting Operation Example .....                    | 8        |
| 5.7.2 Parameter Setting Items .....                                | 12       |
| 5.8 FINE ADJUSTMENT VALUE SETTING.....                             | 15       |
| 5.8.1 Fine Adjustment Value Setting Operation Example .....        | 15       |
| 5.8.2 Fine Adjustment Value Setting Items.....                     | 18       |
| 5.9 DUMPING OF RECEIVE BUFFER .....                                | 19       |
| 5.9.1 Operation Example of Receive Buffer Dumping.....             | 19       |
| 5.10 BASIC EXPANSION MODE .....                                    | 22       |
| 5.11 AUTOMATIC CALIBRATION SETTING.....                            | 23       |
| 5.11.1 Operation Example of Automatic Calibration Setting .....    | 23       |
| 5.12 LAN ENABLE/DISABLE SETTING .....                              | 26       |
| 5.12.1 Operation Example of LAN Enable/Disable Setting .....       | 26       |
| 5.13 REAL TIME CLOCK (RTC) SETTING.....                            | 28       |
| 5.13.1 Operation Example of RTC Setting .....                      | 28       |
| 5.14 BASIC SETTING .....   | 31       |
| 5.14.1 Operation Example of BASIC Setting .....                    | 31       |
| 5.15 LCD MESSAGES AND LED INDICATIONS .....                        | 34       |
| 5.16 LCD MESSAGES IN DIFFERENT LANGUAGES (UPPER LINE OF LCD) ..... | 37       |

|   | Page       |
|---|------------|
| <b>6. SYSTEM MODE.....</b>                                  | <b>39</b>  |
| 6.1 OUTLINE OF SYSTEM MODE .....                            | 39         |
| 6.2 SELF-TEST .....   | 41         |
| 6.2.1 Self-test Operation Example .....                     | 41         |
| 6.2.2 Self-test Items .....                                 | 45         |
| 6.2.2.1 Details of Self-test Result.....                    | 49         |
| 6.3 VARIOUS PARAMETERS SETTING.....                         | 59         |
| 6.3.1 Various Parameters Setting Operation Example.....     | 59         |
| 6.3.2 Details of Various Parameter Setting.....             | 63         |
| 6.4 FINE ADJUSTMENT VALUE SETTING.....                      | 74         |
| 6.4.1 Fine Adjustment Value Setting Operation Example ..... | 74         |
| 6.4.2 Details of Fine Adjustment Value Setting .....        | 76         |
| 6.5 TEST PRINT.....   | 84         |
| 6.5.1 Test Print Operation Example.....                     | 84         |
| 6.5.2 Details of Test Print Setting .....                   | 88         |
| 6.5.3 Test Print Samples.....                               | 92         |
| 6.6 SENSOR DISPLAY/ADJUSTMENT.....                          | 96         |
| 6.6.1 Sensor Display/Adjustment Operation Example.....      | 96         |
| 6.6.2 Details of Sensor Adjustment Value Display .....      | 98         |
| 6.7 RAM CLEAR.....  | 99         |
| 6.7.1 RAM Clear Operation Example.....                      | 99         |
| 6.7.2 Details of RAM Clear .....                            | 101        |
| 6.8 IP ADDRESS SETTING .....                                | 104        |
| 6.8.1 IP Address Setting Operation Example .....            | 104        |
| 6.8.2 IP Address Setting Operation Flow.....                | 111        |
| 6.9 BASIC SETTING .....                                     | 112        |
| 6.9.1 BASIC Setting Operation Example .....                 | 112        |
| 6.10 ADJUSTMENT MODE FOR FACTORY.....                       | 115        |
| 6.11 RFID SETTING.....                                      | 117        |
| 6.11.1 RFID Setting Operation Example.....                  | 117        |
| 6.11.2 Details of RFID Setting .....                        | 121        |
| <b>7. DOWNLOAD MODE.....</b>                                | <b>128</b> |

# 1. SCOPE

This specification describes key operations of the B-SA4T Series general-purpose bar code printers (hereinafter referred to as "B-SA4T") using the B-SA4T keys and the LCD display.

# 2. OUTLINE

The B-SA4T key operations are performed roughly in two modes: online mode and system mode. In online mode, where the B-SA4T is connected to a host device such as a personal computer, the key operations are performed mainly to pause or restart the B-SA4T and to display printer status messages and error messages on the LCD. In system mode, the key operations are performed mainly to conduct a self-test and to make various parameter settings. This specification describes the key operations in these two modes and in download mode.

For explanation purposes, this specification uses English key names and LCD messages, although other languages are available for key names and LCD messages.

# 3. OPERATION PANEL

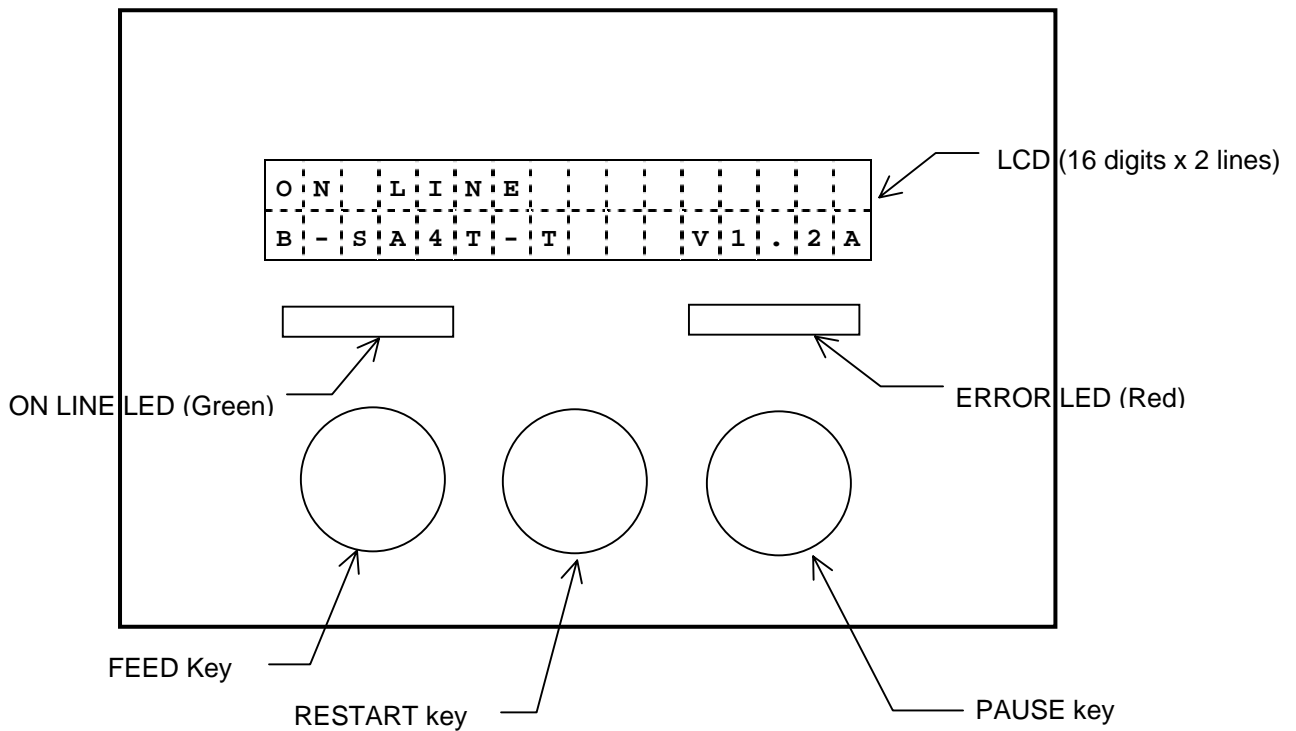

# 4. KEY OPERATION FLOW

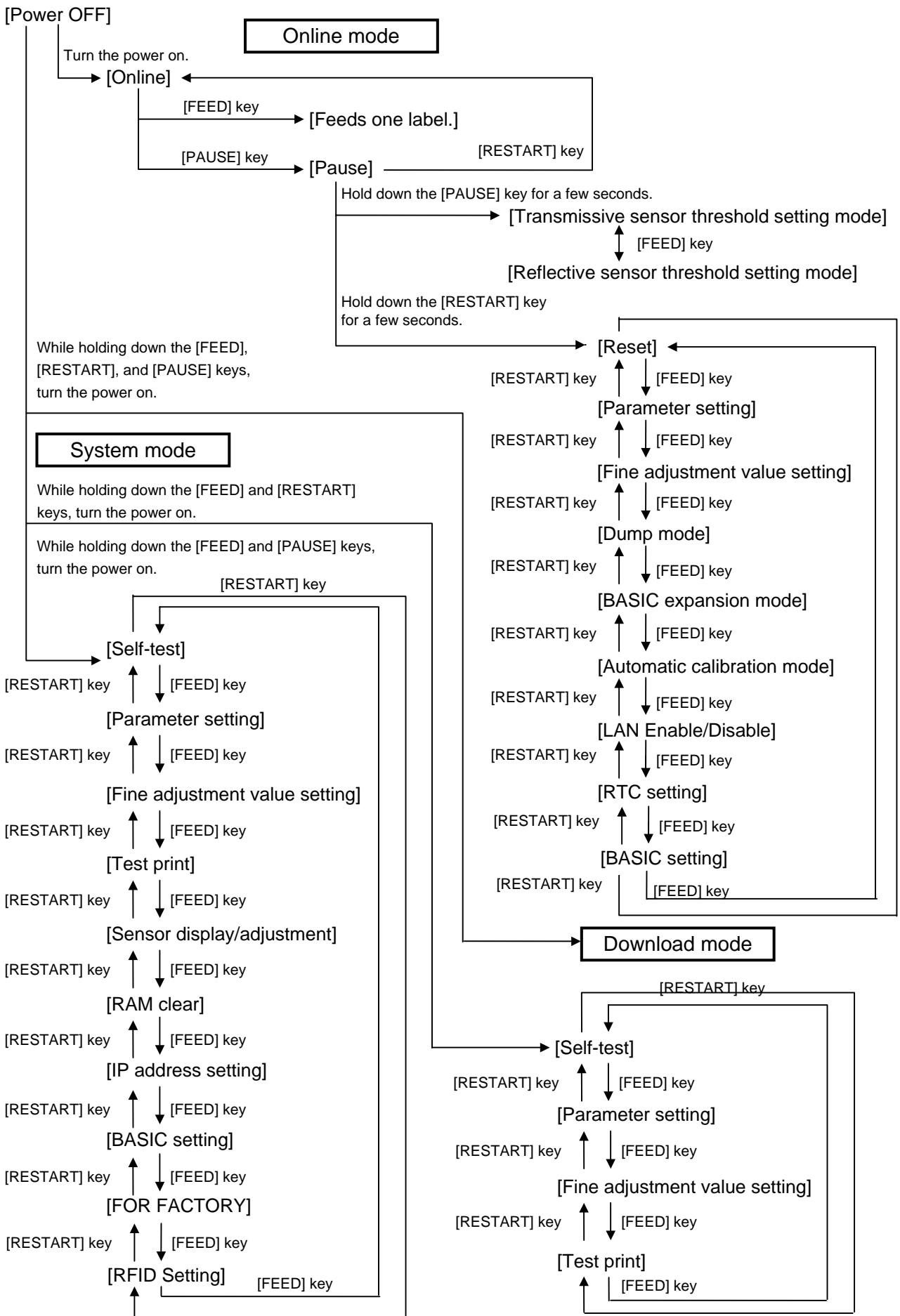

## 5. ONLINE MODE

### 5.1 KEY FUNCTIONS

- [FEED] key:
- (1) Feeds or ejects one label. This key is also used to adjust a label to a proper position. When the label is not properly positioned, feed one or two blank labels using this key before printing so that the printer can start printing at the proper position.
  - (2) Prints data in the image buffer on one label according to the system mode setting.

**NOTE:** *When printing is initiated by the [FEED] key, a Clear command or a drawing command should not be sent during printing, otherwise the resulting printout will not be satisfactory showing an incorrect layout. The same may happen if the [FEED] key is pressed to start printing while data is being drawn in the image buffer.*

\* For handling of labels having the label pitch of less than 22 mm in cut issue mode, refer to the section, "6.4 FINE ADJUSTMENT VALUE SETTING".

- [RESTART] key:
- (1) Resumes printing when the printer is in a pause state or an error state.
  - (2) Restores the same state as when the power is turned off and on again.
  - (3) Programs various parameters.

- [PAUSE] key:
- (1) Stops printing temporarily.
  - (2) Programs threshold values.

### 5.2 LED FUNCTIONS

- [ON LINE] LED: Indicates that the printer is ready for communication.  
[ERROR] LED: Indicates that the printer is in an error state.

### 5.3 LCD FUNCTIONS

The LCD displays printer status messages.  
LCD Size: 16 digits × 2 lines

## 5.4 ONLINE MODE OPERATION EXAMPLE

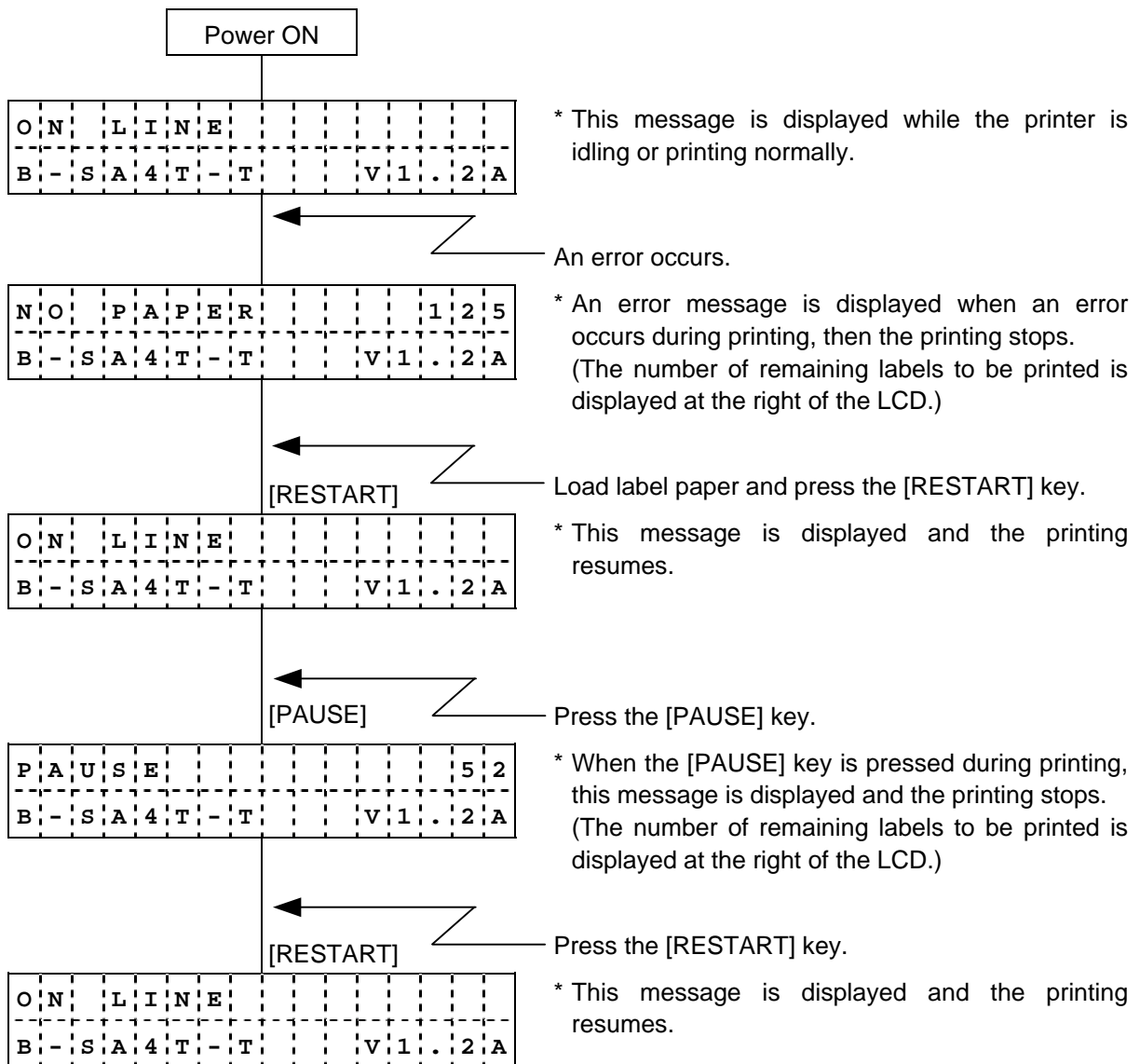

**NOTE:** [Number of remaining labels to be printed] = [Total number of labels to be printed] - [Number of labels already printed before an error occurred or the printer stopped temporarily]

## 5.5 THRESHOLD SETTING

### 5.5.1 Outline of Threshold Setting

To always start printing at a proper position, the printer automatically corrects a print start position using a transmissive or reflective sensor. However, the printer sometimes fails to correct the print start position properly.

For label papers, a transmissive sensor is used to detect a gap between labels. When preprinted labels are used, transmissivity may vary due to inks used, and the printer may not be able to correct the print start position properly. For tag papers with black marks printed on the back side, a reflective sensor is used to detect the black marks. When reflectivity of the area other than the black marks varies, the printer may not be able to correct the print start position properly.

In these cases, the printer can correct the print start position properly by using a transmissive sensor threshold value/reflective sensor threshold value manually determined and stored in a non-volatile memory (EEPROM) by performing the key operation explained in the subsequent section, "Threshold Setting Operation Example" and by setting the type of sensor for Issue and Feed commands to "3: Transmissive Sensor (when using a manual threshold value)" or "4: Reflective Sensor (when using a manual threshold value)".

### 5.5.2 Threshold Setting Operation Example

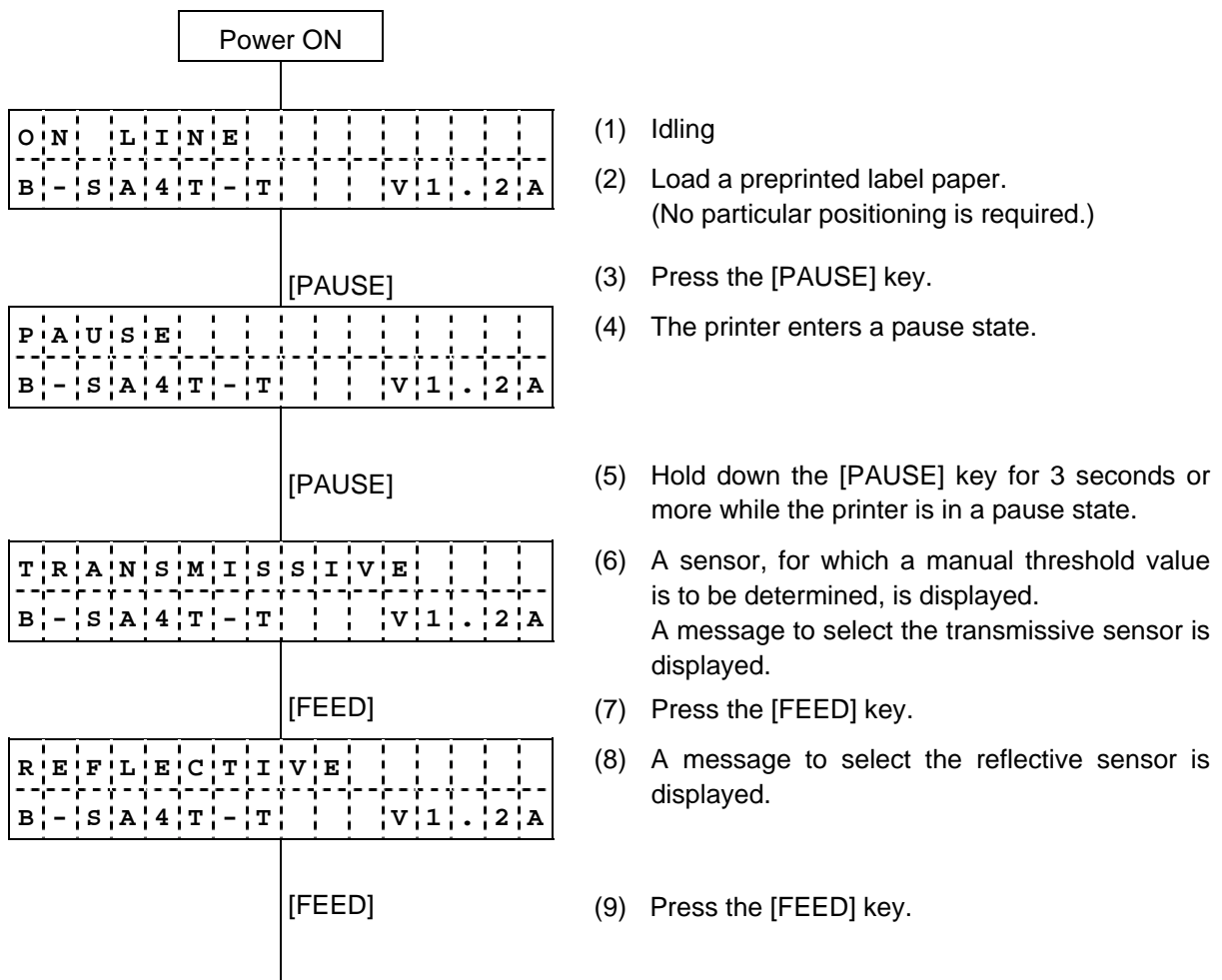



|   |   |   |   |   |   |   |   |   |   |   |   |   |   |   |   |   |  |  |  |
|---|---|---|---|---|---|---|---|---|---|---|---|---|---|---|---|---|--|--|--|
| T | R | A | N | S | M | I | S | S | I | V | E |   |   |   |   |   |  |  |  |
| B | - | S | A | 4 | T | - | T |   |   |   |   | V | 1 | . | 2 | A |  |  |  |

(10) A message to select the transmissive sensor is displayed.

[PAUSE]

(11) Continue holding down the [PAUSE] key.

|   |   |   |   |   |   |   |   |   |   |   |   |   |   |   |   |   |  |  |  |
|---|---|---|---|---|---|---|---|---|---|---|---|---|---|---|---|---|--|--|--|
| T | R | A | N | S | M | I | S | S | I | V | E |   |   |   |   |   |  |  |  |
| B | - | S | A | 4 | T | - | T |   |   |   |   | V | 1 | . | 2 | A |  |  |  |

(12) Release the [PAUSE] key when 1.5 or more labels are fed to stop printing. (The threshold setting for the selected sensor (transmissive sensor in this example) is completed.)

|   |   |   |   |   |   |   |   |  |  |  |  |   |   |   |   |   |  |  |  |
|---|---|---|---|---|---|---|---|--|--|--|--|---|---|---|---|---|--|--|--|
| P | A | U | S | E |   |   |   |  |  |  |  |   |   |   |   |   |  |  |  |
| B | - | S | A | 4 | T | - | T |  |  |  |  | V | 1 | . | 2 | A |  |  |  |

(13) The printer enters a pause state.

[RESTART]

(14) Press the [RESTART] key.

|   |   |   |   |   |   |   |   |  |  |  |  |   |   |   |   |   |  |  |  |
|---|---|---|---|---|---|---|---|--|--|--|--|---|---|---|---|---|--|--|--|
| O | N | L | I | N | E |   |   |  |  |  |  |   |   |   |   |   |  |  |  |
| B | - | S | A | 4 | T | - | T |  |  |  |  | V | 1 | . | 2 | A |  |  |  |

(15) Idling

Command

|   |   |   |   |   |   |   |   |  |  |  |  |   |   |   |   |   |  |  |  |
|---|---|---|---|---|---|---|---|--|--|--|--|---|---|---|---|---|--|--|--|
| O | N | L | I | N | E |   |   |  |  |  |  |   |   |   |   |   |  |  |  |
| B | - | S | A | 4 | T | - | T |  |  |  |  | V | 1 | . | 2 | A |  |  |  |

(16) The printer starts printing according to a command sent from a PC.

<Supplementary Explanations>

- (1) When the [PAUSE] key is pressed and released within 3 seconds while the printer is paused, no action is taken.
- (2) To obtain an accurate threshold value, 1.5 or more labels should be fed. (If less than 1.5 labels are fed, the threshold value may not be accurate enough to start printing at a proper print start position. If the print start position is not correct, the threshold setting operation should be performed again.)
- (3) When the [PAUSE] key is held down for 3 seconds or more with the head lifted, no action is taken.
- (4) While the printer is feeding labels to determine a threshold value, no errors, including paper end error and cutter error, are detected.
- (5) If the printer still does not start printing at the proper print start position after the threshold setting operation is performed, it can be suspected that a sensor adjustment is not proper. In this case, readjust the sensor in system mode, then perform the threshold setting operation again.  
When the backing paper of a label paper is too thick, the transmissive sensor should be readjusted.  
In addition, make sure that the type of sensor for Issue and Feed commands is set to "3: Transmissive sensor (when using a manual threshold value)" or "4: Reflective sensor (when using a manual threshold value)".

## 5.6 RESET

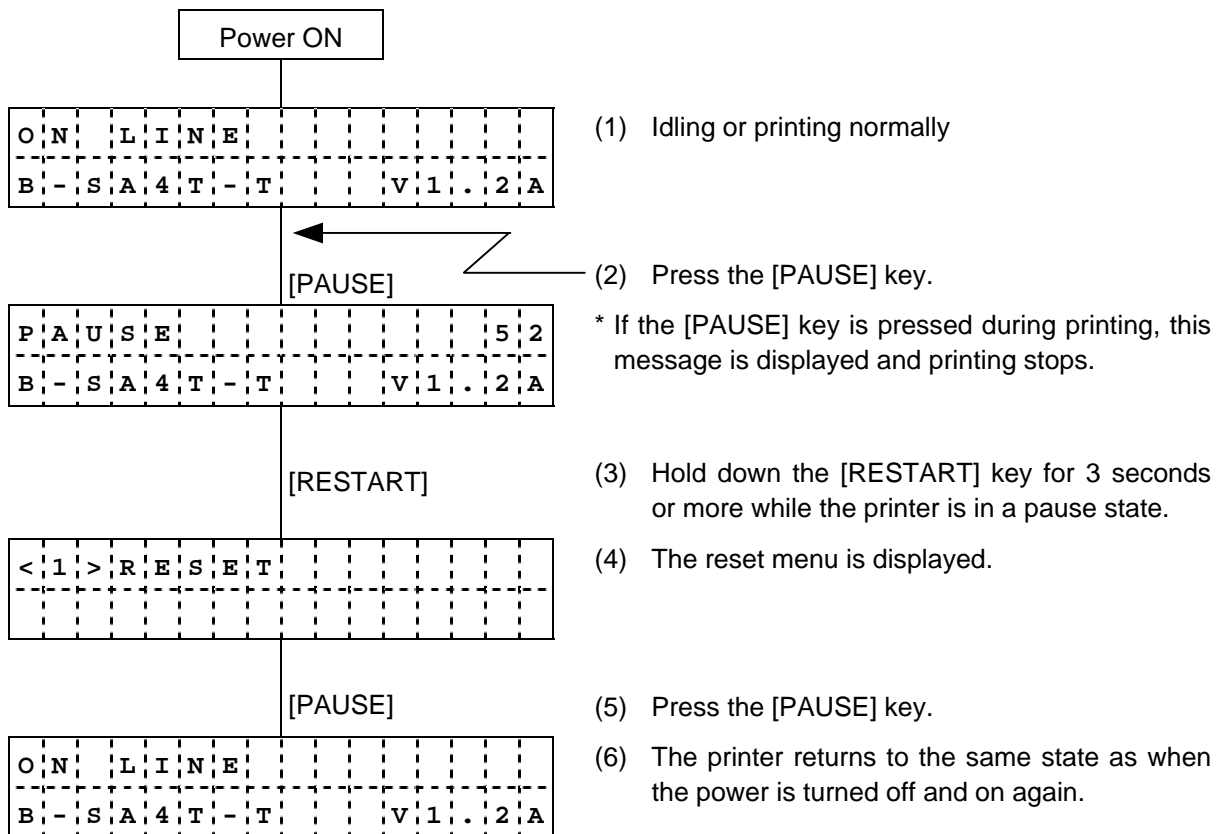

### <Supplementary Explanations>

- (1) When pressing the [RESTART] key can clear an error (a recoverable error by the [RESTART] key), the printer enters reset mode and displays a reset menu when the [RESTART] key is pressed for 3 seconds or more.
- (2) When the [RESTART] key is pressed and released within 3 seconds in an error state or a pause state, the printer resumes printing. (The reset menu is not displayed on the LCD.)  
When the [RESTART] key is pressed in a communication error state or a command error state, the printer returns to the same state as when the power is turned off and on again, whether or not the [RESTART] key is held down for 3 seconds or more.

## 5.7 PARAMETER SETTING

### 5.7.1 Parameter Setting Operation Example

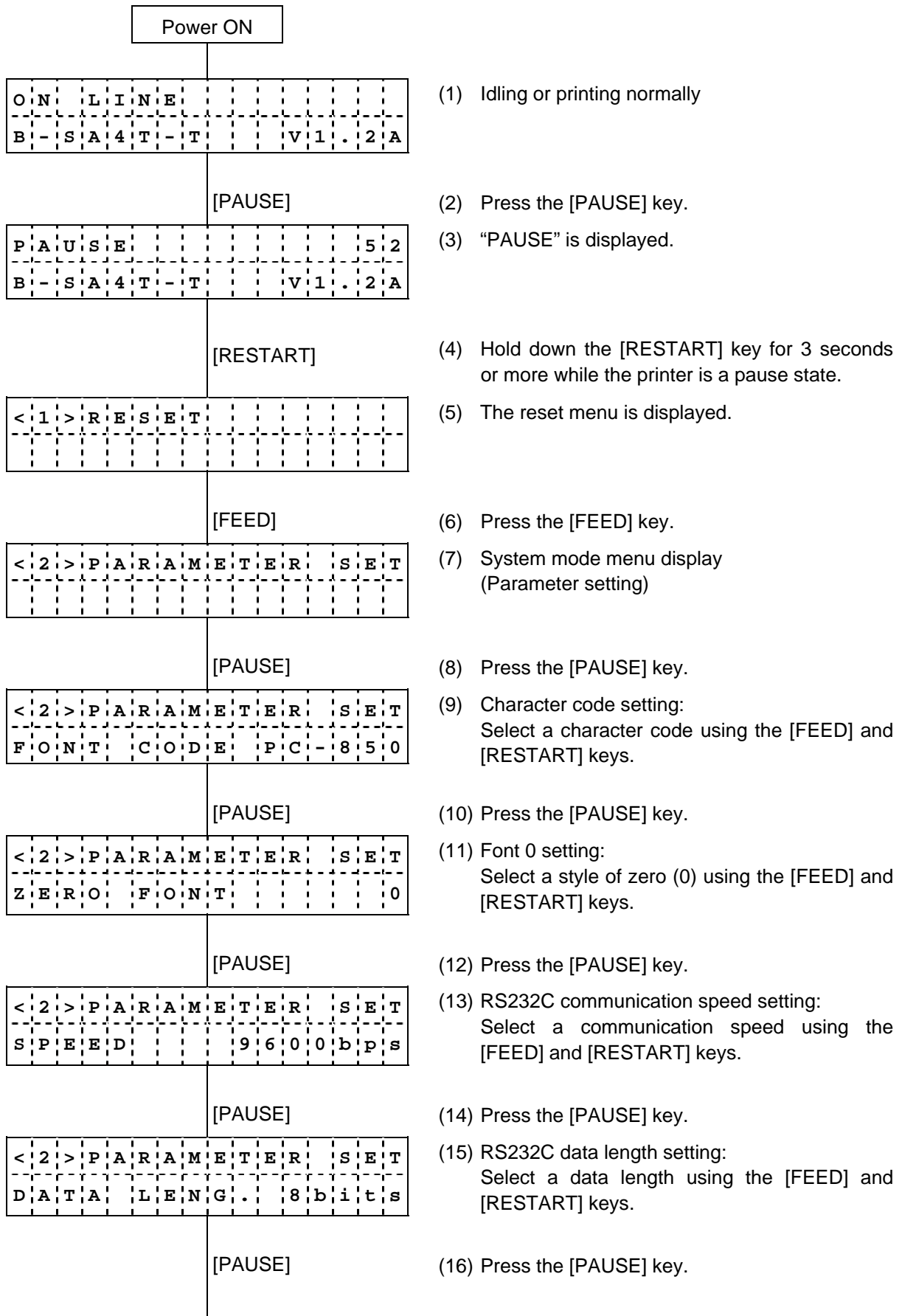

|   |   |   |   |   |   |   |   |   |   |   |   |   |   |   |
|---|---|---|---|---|---|---|---|---|---|---|---|---|---|---|
| < | 2 | > | P | A | R | A | M | E | T | E | R | S | E | T |
| S | T | O | P | B | I | T |   |   |   |   | 1 | b | i | t |

- (17) RS232C stop bit length setting:  
Select a stop bit length using the [FEED] and [RESTART] keys.

[PAUSE]

- (18) Press the [PAUSE] key.

|   |   |   |   |   |   |   |   |   |   |   |   |   |   |   |
|---|---|---|---|---|---|---|---|---|---|---|---|---|---|---|
| < | 2 | > | P | A | R | A | M | E | T | E | R | S | E | T |
| P | A | R | I | T | Y |   |   |   |   |   | E | V | E | N |

- (19) RS232C parity setting:  
Select a parity value using the [FEED] and [RESTART] keys.

[PAUSE]

- (20) Press the [PAUSE] key.

|   |   |   |   |   |   |   |   |   |   |   |   |   |   |   |
|---|---|---|---|---|---|---|---|---|---|---|---|---|---|---|
| < | 2 | > | P | A | R | A | M | E | T | E | R | S | E | T |
| X | O | N | + | R | E | A | D | Y |   |   | A | U | T | O |

- (21) RS232C flow control method setting:  
Select a flow control method using the [FEED] and [RESTART] keys.

[PAUSE]

- (22) Press the [PAUSE] key.

|   |   |   |   |   |   |   |   |   |   |   |   |   |   |   |   |   |   |
|---|---|---|---|---|---|---|---|---|---|---|---|---|---|---|---|---|---|
| < | 2 | > | P | A | R | A | M | E | T | E | R | S | E | T |   |   |   |
| L | C | D |   |   |   |   |   |   |   |   | E | N | G | L | I | S | H |

- (23) Setting of language for LCD messages:  
Select a language for LCD messages using the [FEED] and [RESTART] keys.

[PAUSE]

- (24) Press the [PAUSE] key.

|   |   |   |   |   |   |   |   |   |   |   |   |   |   |   |  |   |   |   |
|---|---|---|---|---|---|---|---|---|---|---|---|---|---|---|--|---|---|---|
| < | 2 | > | P | A | R | A | M | E | T | E | R | S | E | T |  |   |   |   |
| F | O | R | W | A | R | D |   |   |   |   | W | A | I | T |  | O | F | F |

- (25) Setting of forward feed standby after an issue:  
Enable/disable the forward feed standby function using the [FEED] and [RESTART] keys.

[PAUSE]

- (26) Press the [PAUSE] key.

|   |   |   |   |   |   |   |   |   |   |   |   |   |   |   |   |
|---|---|---|---|---|---|---|---|---|---|---|---|---|---|---|---|
| < | 2 | > | P | A | R | A | M | E | T | E | R | S | E | T |   |
| C | O | D | E |   |   | E | S | C | , | L | F | , | N | U | L |

- (27) Control code setting:  
Select a control code using the [FEED] and [RESTART] keys.

[PAUSE]

- (28) Press the [PAUSE] key.

|   |   |   |   |   |   |   |   |   |   |   |   |   |   |   |  |   |   |   |
|---|---|---|---|---|---|---|---|---|---|---|---|---|---|---|--|---|---|---|
| < | 2 | > | P | A | R | A | M | E | T | E | R | S | E | T |  |   |   |   |
| P | E | E | L |   |   | O | F | F |   |   | S | T | S |   |  | O | F | F |

- (29) Strip wait status setting:  
Enable/disable the strip wait status function using the [FEED] and [RESTART] keys.

[PAUSE]

- (30) Press the [PAUSE] key.

|   |   |   |   |   |   |   |   |   |   |   |   |   |   |   |
|---|---|---|---|---|---|---|---|---|---|---|---|---|---|---|
| < | 2 | > | P | A | R | A | M | E | T | E | R | S | E | T |
| F | E | E | D |   |   | K | E | Y |   |   | F | E | E | D |

- (31) [FEED] key function setting:  
Select a function of the [FEED] key using the [FEED] and [RESTART] keys.

[PAUSE]

- (32) Press the [PAUSE] key.

|   |   |   |   |   |   |   |   |   |   |   |   |   |   |   |   |
|---|---|---|---|---|---|---|---|---|---|---|---|---|---|---|---|
| < | 2 | > | P | A | R | A | M | E | T | E | R | S | E | T |   |
| K | A | N | J | I |   | C | O | D | E |   | T | Y | P | E | 1 |

- (33) Kanji code setting:  
Select a Kanji code using the [FEED] and [RESTART] keys.

[PAUSE]

- (34) Press the [PAUSE] key.

|   |   |   |   |   |   |   |   |   |   |   |   |   |   |   |
|---|---|---|---|---|---|---|---|---|---|---|---|---|---|---|
| < | 2 | > | P | A | R | A | M | E | T | E | R | S | E | T |
| E | U | R | O | C | O | D | E |   |   |   |   |   | B | 0 |

- (35) Euro code setting:  
Select a Euro code using the [FEED] and [RESTART] keys.

[PAUSE]

- (36) Press the [PAUSE] key.

|   |   |   |   |   |   |   |   |   |   |   |   |   |   |   |
|---|---|---|---|---|---|---|---|---|---|---|---|---|---|---|
| < | 2 | > | P | A | R | A | M | E | T | E | R | S | E | T |
| A | U | T | O | H | I | D | C | H | K |   |   | O | F | F |

- (37) Automatic head broken dots check setting:  
Enable/disable the automatic head broken dots check using the [FEED] and [RESTART] keys.

[PAUSE]

- (38) Press the [PAUSE] key.

|   |   |   |   |   |   |   |   |   |   |   |   |   |   |   |
|---|---|---|---|---|---|---|---|---|---|---|---|---|---|---|
| < | 2 | > | P | A | R | A | M | E | T | E | R | S | E | T |
| A | C | K | / | B | U | S | Y |   |   | T | Y | P | E | 1 |

- (39) Centronics ACK/BUSY timing setting:  
Select an ACK/BUSY timing using the [FEED] and [RESTART] keys.

[PAUSE]

- (40) Press the [PAUSE] key.

|   |   |   |   |   |   |   |   |   |   |   |   |   |   |   |
|---|---|---|---|---|---|---|---|---|---|---|---|---|---|---|
| < | 2 | > | P | A | R | A | M | E | T | E | R | S | E | T |
| W | E | B |   | P | R | I | N | T | E | R |   | O | F | F |

- (41) Web printer function setting:  
Enable/disable the web printer function using the [FEED] and [RESTART] keys.

[PAUSE]

- (42) Press the [PAUSE] key.

|   |   |   |   |   |   |   |   |   |   |   |   |   |   |   |
|---|---|---|---|---|---|---|---|---|---|---|---|---|---|---|
| < | 2 | > | P | A | R | A | M | E | T | E | R | S | E | T |
| I | N | P | U | T |   | P | R | I | M | E |   | O | N |   |

- (43) Setting of reset process when the nlnit signal is ON:  
Enable/disable the reset process function using the [FEED] and [RESTART] keys.

[PAUSE]

- (44) Press the [PAUSE] key.

|   |   |   |   |   |   |   |   |   |   |   |   |   |   |   |
|---|---|---|---|---|---|---|---|---|---|---|---|---|---|---|
| < | 2 | > | P | A | R | A | M | E | T | E | R | S | E | T |
| R | B | N |   | N | E | A | R |   | E | N | D |   | 7 | 0 |

- (45) Ribbon near end detection setting:  
Select a remaining ribbon length to be detected as a ribbon near end state using the [FEED] and [RESTART] keys.

[PAUSE]

- (46) Press the [PAUSE] key.

|   |   |   |   |   |   |   |   |   |   |   |   |   |   |   |
|---|---|---|---|---|---|---|---|---|---|---|---|---|---|---|
| < | 2 | > | P | A | R | A | M | E | T | E | R | S | E | T |
| E | X | . | I | / | O |   |   |   |   | T | Y | P | E | 1 |

- (47) Expansion I/O operation mode setting:  
Select an expansion I/O operation mode using the [FEED] and [RESTART] keys.

[PAUSE]

- (48) Press the [PAUSE] key.

|   |   |   |   |   |   |   |   |   |   |   |   |   |   |   |
|---|---|---|---|---|---|---|---|---|---|---|---|---|---|---|
| < | 2 | > | P | A | R | A | M | E | T | E | R | S | E | T |
| P | L | U | G |   | & |   | P | L | A | Y |   | O | F | F |

- (49) Plug-and-play operation setting:  
Enable/disable the plug-and-play operation function using the [FEED] and [RESTART] keys.

[PAUSE]

- (50) Press the [PAUSE] key.

|   |   |   |   |   |   |   |   |   |   |   |   |   |   |   |
|---|---|---|---|---|---|---|---|---|---|---|---|---|---|---|
| < | 2 | > | P | A | R | A | M | E | T | E | R | S | E | T |
| L | B | L | / | R | B | N |   | E | N | D |   | T | Y | P |

- (51) Label end/ribbon error process setting:  
Select a label end/ribbon error process using the [FEED] and [RESTART] keys.

[PAUSE]

- (52) Press the [PAUSE] key.

|   |   |   |   |   |   |   |   |   |   |   |   |   |   |   |
|---|---|---|---|---|---|---|---|---|---|---|---|---|---|---|
| < | 2 | > | P | A | R | A | M | E | T | E | R | S | E | T |
| P | R | E | P | E | E | L | O | F | F | O | F | F |   |   |

(53) Pre-strip function setting:  
Enable/disable the pre-strip function using the [FEED] and [RESTART] keys.

[PAUSE]

(54) Press the [PAUSE] key.

|   |   |   |   |   |   |   |   |   |   |   |   |   |   |   |
|---|---|---|---|---|---|---|---|---|---|---|---|---|---|---|
| < | 2 | > | P | A | R | A | M | E | T | E | R | S | E | T |
| B | A | C | K | S | P | E | E | D | S | T | D |   |   |   |

(55) Reverse feed speed setting:  
Select a reverse feed speed using the [FEED] and [RESTART] keys.

[PAUSE]

(56) Press the [PAUSE] key.

|   |   |   |   |   |   |   |   |   |   |   |   |   |   |   |
|---|---|---|---|---|---|---|---|---|---|---|---|---|---|---|
| < | 2 | > | P | A | R | A | M | E | T | E | R | S | E | T |
| M | A | X | I | C | O | D | E | T | Y | P | E | 1 |   |   |

(57) MaxiCode specification setting:  
Select a type of MaxiCode specification using the [FEED] and [RESTART] keys.

[PAUSE]

(58) Press the [PAUSE] key.

|   |   |   |   |   |   |   |   |   |   |   |   |   |   |   |
|---|---|---|---|---|---|---|---|---|---|---|---|---|---|---|
| < | 2 | > | P | A | R | A | M | E | T | E | R | S | E | T |
| K | B | I | / | F |   |   |   |   |   |   |   | O | F | F |

(59) Keyboard I/F setting:  
Enable/disable the keyboard I/F using the [FEED] and [RESTART] keys.

[PAUSE]

(60) Press the [PAUSE] key.

|   |   |   |   |   |   |   |   |   |   |   |   |   |   |   |
|---|---|---|---|---|---|---|---|---|---|---|---|---|---|---|
| < | 2 | > | P | A | R | A | M | E | T | E | R | S | E | T |
| P | E | E | L | O | F | F | T | R | Q | R | 0 |   |   |   |

(61) Strip motor torque setting:  
Select a strip motor torque using the [FEED] and [RESTART] keys.

[PAUSE]

(62) Press the [PAUSE] key.

|   |   |   |   |   |   |   |   |   |   |   |   |   |   |   |
|---|---|---|---|---|---|---|---|---|---|---|---|---|---|---|
| < | 2 | > | P | A | R | A | M | E | T | E | R | S | E | T |
| T | O | N | E | T | A | B | L | E | T | Y | P | E | 1 |   |

(63) Print head applied current table setting:  
Select the type of table using the [FEED] or [RESTART] key.

[PAUSE]

(64) Press the [PAUSE] key.

|   |   |   |   |   |   |   |   |   |   |   |   |   |   |   |
|---|---|---|---|---|---|---|---|---|---|---|---|---|---|---|
| < | 2 | > | P | A | R | A | M | E | T | E | R | S | E | T |
|   |   |   |   |   |   |   |   |   |   |   |   |   |   |   |

(65) The parameter setting menu is displayed.

## 5.7.2 Parameter Setting Items

For details, refer to the section, "6.3 VARIOUS PARAMETER SETTING".

- (1) Character code (FONT CODE)
  - PC-850
  - PC-851
  - PC-1250
  - PC-1252
  - PC-1254
  - LATIN9
  - PC-855
  - UTF-8
  - PC-852
  - PC-8
  - PC-855
  - PC-1251
  - PC-1253
  - PC-1257
  - Arabic
  - PC-866
- (2) Font 0 (ZERO FONT)
  - 0 (without slash)
  - 0 (with slash)
- (3) RS-232C communication speed (SPEED)
  - 2400 bps
  - 4800 bps
  - 9600 bps
  - 19200 bps
  - 38400 bps
  - 115200 bps
- (4) RS-232C data length (DATA LENG.)
  - 7 bits
  - 8 bits
- (5) RS-232C stop bit length (STOP BIT)
  - 1 bit
  - 2 bits
- (6) RS-232C parity (PARITY)
  - NONE
  - EVEN
  - ODD
- (7) RS-232C flow control method (XON+READY)
  - XON/XOFF protocol (An XON is not output when the power is on and an XOFF is not output when the power is off.)
  - READY/BUSY (DTR) protocol (An XON is not output when the power is on and an XOFF is not output when the power is off.)
  - XON/XOFF + READY/BUSY (DTR) protocol (An XON is output when the power is on and an XOFF is output when the power is off)
  - XON/XOFF protocol (An XON is output when the power is on and an XOFF is output when the power is off)
  - RTS protocol (An XON is not output when the power is on and an XOFF is not output when the power is off)

- (8) Language for LCD messages (LCD)
- ENGLISH
  - GERMAN
  - FRENCH
  - DUTCH
  - SPANISH
  - JAPANESE
  - ITALIAN
- NOTE:** *Japanese character codes are slightly different from those of other languages. For details, refer to the External Equipment Interface Specification (TAA-2165).*
- (9) Forward feed standby after an issue (FORWARD WAIT)
- ON: The forward feed standby after an issue function is enabled.
  - POSITION: A fine adjustment value for a stop position after a forward feed is set.
  - OFF: The forward feed standby after an issue function is disabled.
- NOTE:** *When the forward feed standby after an issue parameter is set to ON, the printer enters a pause state after a label is issued. The printer automatically starts to feed the label approximately 17 mm forward when a time of 1 second or more passes in the pause state, then stops.*
- (10) Control code (CODE)
- Automatic selection (ESC, LF, NUL/{ | })
  - Manual selection (ESC, LF, NUL method)
  - Manual selection ({ | } method)
  - Any code set
  - Manual selection (Γ | ⊥) method *Note: Only for the Japan model.*
- (11) Strip wait status (PEEL OFF STS)
- ON: The strip wait status function is enabled.
  - OFF: The strip wait status function is disabled.
- (12) [FEED] key function (FEED KEY)
- FEED: Feeds one label.
  - PRINT: Prints data in the image buffer on one label.
- (13) Kanji code (KANJI CODE)
- TYPE1 (For Windows codes)
  - TYPE2 (For original codes)
- (14) Euro code (EURO CODE)
- 20H to FFH
- (15) Automatic head broken dots check (AUTO HD CHK)
- ON: A head broken dots check is automatically performed when the power is turned on.
  - OFF: A head broken dots check is not automatically performed when the power is turned on.
- (16) Centronics ACK/BUSY timing (ACK/BUSY)
- TYPE1 BUSY goes low at the same time as when ACK goes high.
  - TYPE2 BUSY goes low at the same time as when ACK goes low.
- (17) Web printer function (WEB PRINTER)
- ON: The web printer function is enabled.
  - OFF: The web printer function is disabled.
- (18) Reset process when the nInit signal is ON (INPUT PRIME)
- ON: The reset process is performed.
  - OFF: The reset process is not performed.



- (19) Ribbon near end detection (RBN NEAR END)
  - OFF: A ribbon near end state is not detected.
  - 30 m: A ribbon near end state is detected when the remaining ribbon length is approximately 30 m.
  - 70 m: A ribbon near end state is detected when the remaining ribbon length is approximately 70 m.
- (20) Expansion I/O operation mode (EX. I/O)
  - TYPE1: Standard mode
  - TYPE2: In-line mode
- (21) Plug-and-play operation (PLUG & PLAY)
  - ON: A plug-and-play operation is performed.
  - OFF: A plug-and-play operation is performed.
- (22) Label end/ribbon error process (LBL/RBN END)
  - TYPE1: When a label end or ribbon error state is detected, the printer stops even if it is printing.
  - TYPE2: When a label end or ribbon error state is detected, the printer prints the current label as far as possible, then stops.
- (23) Pre-strip process (PRE PEEL OFF)
  - OFF: A pre-strip operation is not performed.
  - ON: A pre-strip operation is performed.

**NOTE:** *When the pre-strip operation parameter is set to ON, a 6-mm forward feed is performed, then a 6-mm reverse feed before printing on the label starts. The amount of feed can be finely adjusted.*
- (24) Reverse feed speed (BACK SPEED)
  - STD: 3 ips
  - LOW: 2 ips
- (25) MaxiCode specification (MAXI CODE)
  - TYPE1: Compatible with a current version
  - TYPE2: Special specification
- (26) Keyboard I/F (KB I/F)
  - OFF: (Disabled)
  - KB60(1): KB-60 Old version
  - KB60(2): KB-60 Current version
  - KB80: KB-80
- (27) Strip motor torque (PEEL OFF TRQ)
  - R0: Low
  - R1: ↑
  - R2: ↓
  - R3: High
- (28) Print head applied current table setting (TONE TABLE)
  - TYPE1: Standard table
  - TYPE2: Additional table 1

## 5.8 FINE ADJUSTMENT VALUE SETTING

### 5.8.1 Fine Adjustment Value Setting Operation Example

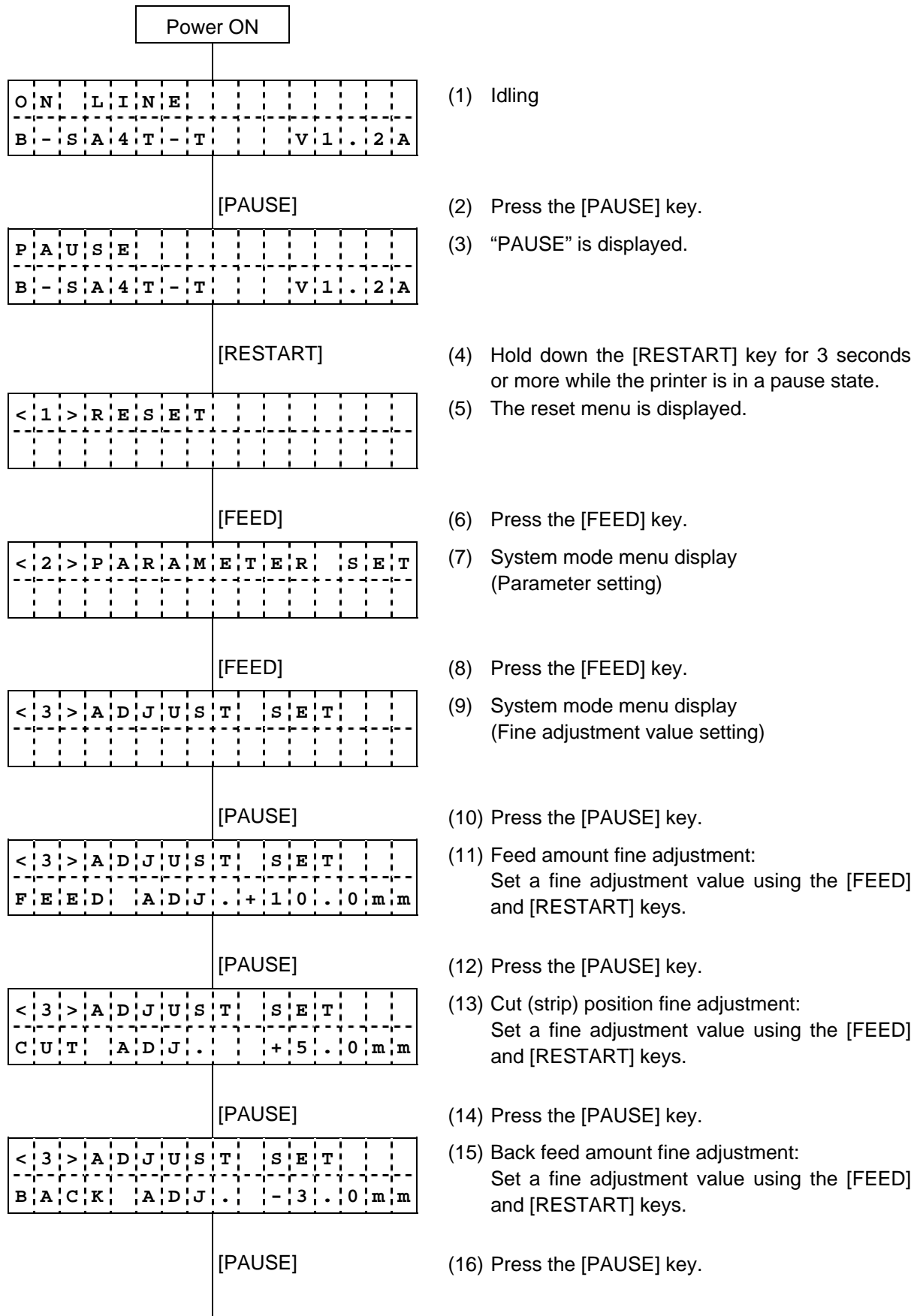

|   |   |   |   |   |   |   |   |   |   |   |   |   |   |
|---|---|---|---|---|---|---|---|---|---|---|---|---|---|
| < | 3 | > | A | D | J | U | S | T | S | E | T |   |   |
| X | A | D | J | U | S | T | + | 5 | 0 | . | 0 | m | m |

- (17) X-coordinate fine adjustment:  
Set a fine adjustment value using the [FEED] and [RESTART] keys.

[PAUSE]

- (18) Press the [PAUSE] key.

|   |   |   |   |   |   |   |   |   |   |   |   |   |   |
|---|---|---|---|---|---|---|---|---|---|---|---|---|---|
| < | 3 | > | A | D | J | U | S | T | S | E | T |   |   |
| T | O | N | E | A | D | J | . | < | T | > |   | + | 3 |

- (19) Print tone fine adjustment  
(Thermal transfer print mode):  
Set a fine adjustment value using the [FEED] and [RESTART] keys.

[PAUSE]

- (20) Press the [PAUSE] key.

|   |   |   |   |   |   |   |   |   |   |   |   |   |   |
|---|---|---|---|---|---|---|---|---|---|---|---|---|---|
| < | 3 | > | A | D | J | U | S | T | S | E | T |   |   |
| T | O | N | E | A | D | J | . | < | D | > |   | - | 2 |

- (21) Print tone fine adjustment  
(Direct thermal print mode):  
Set a fine adjustment value using the [FEED] and [RESTART] keys.

[PAUSE]

- (22) Press the [PAUSE] key.

|   |   |   |   |   |   |   |   |   |   |   |   |   |   |
|---|---|---|---|---|---|---|---|---|---|---|---|---|---|
| < | 3 | > | A | D | J | U | S | T | S | E | T |   |   |
| R | B | N | A | D | J | < | F | W | > |   | - | 1 | 0 |

- (23) Ribbon motor drive voltage fine adjustment  
(Take-up):  
Set a fine adjustment value using the [FEED] and [RESTART] keys.

[PAUSE]

- (24) Press the [PAUSE] key.

|   |   |   |   |   |   |   |   |   |   |   |   |   |  |
|---|---|---|---|---|---|---|---|---|---|---|---|---|--|
| < | 3 | > | A | D | J | U | S | T | S | E | T |   |  |
| R | B | N | A | D | J | < | B | K | > |   | - | 5 |  |

- (25) Ribbon motor drive voltage fine adjustment  
(Feed):  
Set a fine adjustment value using the [FEED] and [RESTART] keys.

[PAUSE]

- (26) Press the [PAUSE] key.

|   |   |   |   |   |   |   |   |   |   |   |   |   |    |   |
|---|---|---|---|---|---|---|---|---|---|---|---|---|----|---|
| < | 3 | > | A | D | J | U | S | T | S | E | T |   |    |   |
| T | H | R | E | S | H | O | L | D | < | R | > | 1 | .0 | V |

- (27) Reflective sensor manual threshold fine adjustment:  
Set a fine adjustment value using the [FEED] and [RESTART] keys.

[PAUSE]

- (28) Press the [PAUSE] key.

|   |   |   |   |   |   |   |   |   |   |   |   |   |    |   |
|---|---|---|---|---|---|---|---|---|---|---|---|---|----|---|
| < | 3 | > | A | D | J | U | S | T | S | E | T |   |    |   |
| T | H | R | E | S | H | O | L | D | < | T | > | 1 | .4 | V |

- (29) Transmissive sensor manual threshold fine adjustment:  
Set a fine adjustment value using the [FEED] and [RESTART] keys.

[PAUSE]

- (30) Press the [PAUSE] key.

|   |   |   |   |   |   |   |   |   |   |   |   |  |  |
|---|---|---|---|---|---|---|---|---|---|---|---|--|--|
| < | 3 | > | A | D | J | U | S | T | S | E | T |  |  |
|   |   |   |   |   |   |   |   |   |   |   |   |  |  |

- (31) The find adjustment value setting menu is displayed.

[RESTART]

- (32) Press the [RESTART] key.

|   |   |   |   |   |   |   |   |   |   |   |   |   |   |   |
|---|---|---|---|---|---|---|---|---|---|---|---|---|---|---|
| < | 2 | > | P | A | R | A | M | E | T | E | R | S | E | T |
|   |   |   |   |   |   |   |   |   |   |   |   |   |   |   |

- (33) The parameter setting menu is displayed.

[RESTART]

- (34) Press the [RESTART] key.

|   |   |   |   |   |   |   |   |  |  |  |  |  |  |  |  |  |  |
|---|---|---|---|---|---|---|---|--|--|--|--|--|--|--|--|--|--|
| < | 1 | > | R | E | S | E | T |  |  |  |  |  |  |  |  |  |  |
|   |   |   |   |   |   |   |   |  |  |  |  |  |  |  |  |  |  |

(35) The reset menu is displayed.

[PAUSE]

(36) Press the [PAUSE] key.

|   |   |   |   |   |   |   |   |  |  |   |   |   |   |   |  |  |
|---|---|---|---|---|---|---|---|--|--|---|---|---|---|---|--|--|
| O | N |   | L | I | N | E |   |  |  |   |   |   |   |   |  |  |
| B | - | S | A | 4 | T | - | T |  |  | V | 1 | . | 2 | A |  |  |

(37) The printer returns to the same state as when the power is turned off and on again.

### 5.8.2 Fine Adjustment Value Setting Items

For details, refer to the section, "6.4 VARIOUS FINE ADJUSTMENT VALUE SETTING".

- (1) Feed fine adjustment (FEED ADJ.)  
-50.0 mm to +50.0 mm (in 0.1 mm units)
- (2) Cut (strip) position fine adjustment (CUT ADJ.)  
-50.0 mm to +50.0 mm (in 0.1 mm units)
- (3) Back feed fine adjustment (BACK ADJ.)  
-9.9 mm to +9.9 mm (in 0.1 mm units)
- (4) X-coordinate fine adjustment (X ADJUST)  
-99.9 mm to +99.9 mm (in 0.1 mm units)
- (5) Print density fine adjustment (Thermal transfer print mode) (TONE ADJ.<T>)  
-10 step to +10 step (in units of 1 step)
- (6) Print density fine adjustment (Direct thermal print mode) (TONE ADJ.<D>)  
-10 step to +10 step (in units of 1 step)
- (7) Ribbon motor drive voltage fine adjustment (Take-up) (RBN ADJ <FW>)  
-15 step to +2 step (in units of 1 step)
- (8) Ribbon motor drive voltage fine adjustment (Feed) (RBN ADJ <BK>)  
-15 step to +10 step (in units of 1 step)
- (9) Reflective sensor manual threshold fine adjustment (THRESHOLD <R>)  
0.0 V to 4.0 V
- (10) Transmissive sensor manual threshold fine adjustment (THRESHOLD <T>)  
0.0 V to 4.0 V

## 5.9 DUMPING OF RECEIVE BUFFER

### 5.9.1 Operation Example of Receive Buffer Dumping

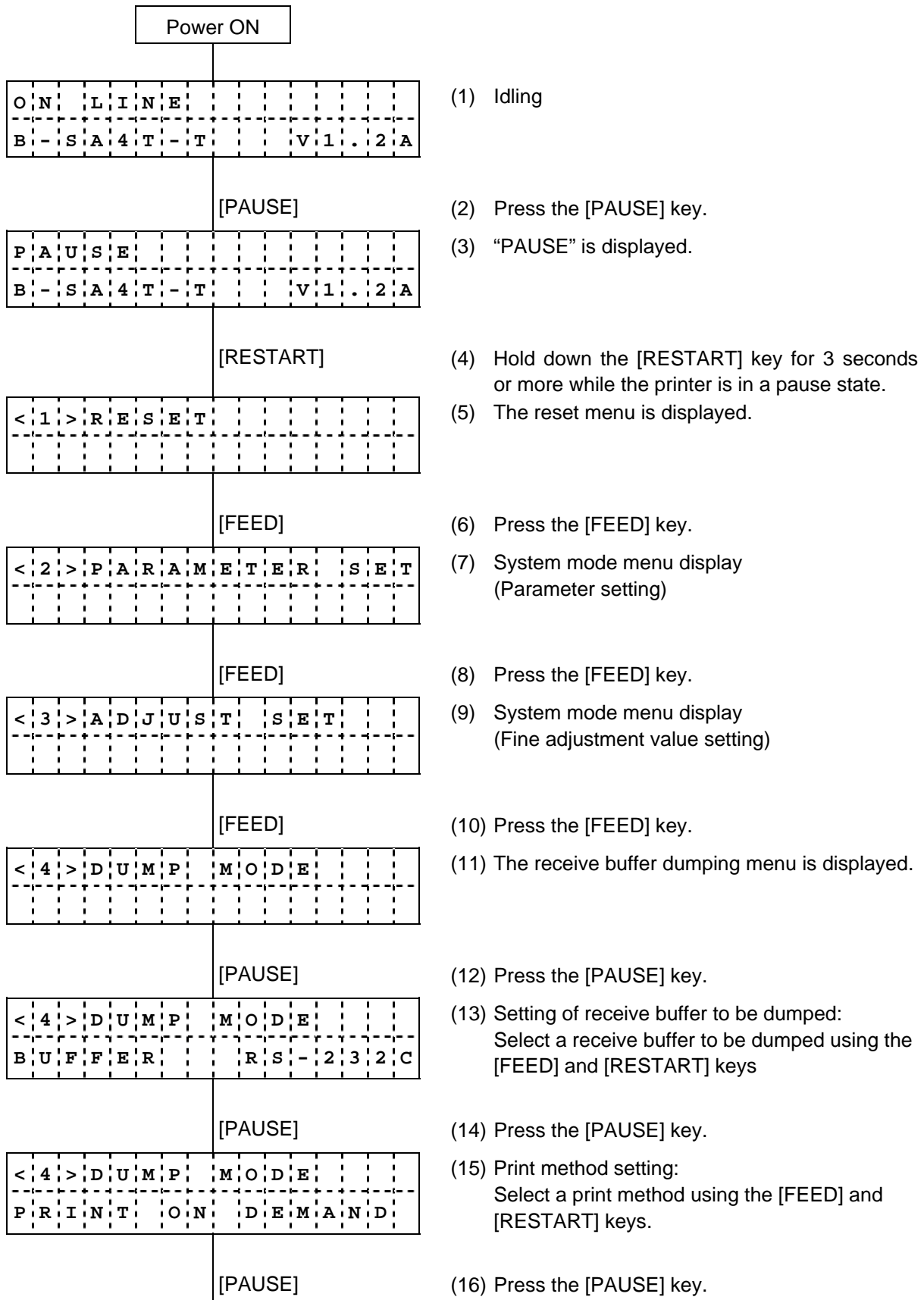

```

< 4 > D U M P   M O D E
N O W   P R I N T I N G . . .

```

(17) Start of printing receive buffer data

(18) 166 lines of data are printed.

```

< 4 > D U M P   M O D E
P R I N T   O N   D E M A N D

```

(19) Print method setting:  
Select a print method using the [FEED] and [RESTART] keys.

[RESTART]

(20) Press the [RESTART] key.

```

< 4 > D U M P   M O D E
P R I N T   A L L

```

(21) Print method setting:  
Select a print method using the [FEED] and [RESTART] keys.

[PAUSE]

(22) Press the [PAUSE] key.

```

< 4 > D U M P   M O D E
N O W   P R I N T I N G . . .

```

(23) Start of printing the remaining receive buffer data

(24) All of the remaining data is printed.

```

< 4 > D U M P   M O D E

```

(25) After printing is completed, the display is returned to the receive buffer dumping menu.

#### Receive buffer (BUFFER)

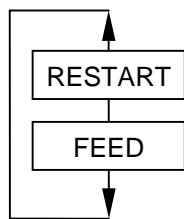

- RS-232C RS-232C receive buffer
- CENTRO. Centronics receive buffer
- NETWORK Network I/F receive buffer
- BASIC1 Buffer between the BASIC interpreter I/F and the Interpreter
- BASIC2 Buffer between the BASIC interpreter and the printer
- USB USB receive buffer
- RF-ID RFID receive buffer

#### Print method (PRINT)

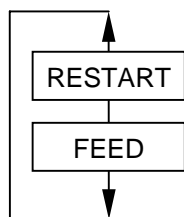

- ON DEMAND Prints 166 lines of data (approx. 50 cm), then stops.
- ALL Prints all data in the receive buffer, then stops.

Data in the receive buffer is printed in the format below.

```

00 00 00 00 00 00 00 00 00 00 00 00 00 00 00 00 .....
00 00 00 00 00 00 00 00 00 00 00 00 00 00 00 00 .....
00 00 00 00 00 00 00 00 00 00 00 00 00 00 00 00 .....
00 00 00 00 00 00 00 00 00 00 00 00 00 00 00 00 .....
7B 41 58 3B 2B 30 30 30 2C 2B 30 30 30 2C 2B 30 {AX;+000,+000,+0
30 7C 7D 7B 44 30 37 37 30 2C 31 31 30 30 2C 30 0|}{D0760,1100,0
37 34 30 7C 7D 7B 43 7C 7D 7B 4C 43 3B 30 30 33 740|}{C|}{LC;003
30 2C 30 30 32 30 2C 30 30 33 30 2C 30 36 36 30 0,0020,0030,0660
2C 30 2C 32 7C 7D 7B 4C 43 3B 30 30 37 30 2C 30 ,0,2|}{LC;0070,0
30 32 30 2C 30 30 37 30 2C 30 36 36 30 2C 30 2C 020,0070,0660,0,
39 7C 7D 7B 4C 43 3B 30 30 35 30 2C 30 30 32 30 9|}{LC;0050,0020

44 45 46 47 48 49 4A 7C 7D 7B 50 43 31 30 3B 30 DEFGHIJ|}{PC10;0
33 35 30 2C 30 34 30 30 2C 31 2C 31 2C 4B 2C 30 350,0400,1,1,K,0
30 2C 42 3D 41 42 43 44 65 66 67 68 69 6A 6B 6C 0,B=ABCDefghijkl

6D 6E 6F 70 7C 7D 7B 50 56 30 32 3B 30 33 33 30 mnop|}{PV02;0330
2C 30 36 36 30 2C 30 32 37 30 2C 30 32 35 30 2C ,0660,0270,0250,
41 2C 30 30 2C 42 3D 42 7C 7D 7B 50 56 30 33 3B A,00,B=B|}{PV03;

3B 30 39 30 30 2C 30 31 38 30 2C 54 2C 48 2C 30 ;0900,0180,T,H,0
35 2C 41 2C 30 3D 31 32 33 34 35 36 37 38 39 30 5,A,0=1234567890
41 42 43 44 45 7C 7D 00 00 00 00 00 00 00 00 00 ABCDE|}.....

```

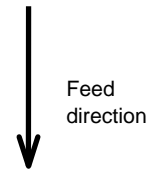



Print conditions:

- Print width: Approximately 100 mm
- Sensor: Not used
- Print speed: 4 ips
- A currently selected print mode (thermal transfer/direct thermal) is used.
- Data of 16 bytes is printed on one line.
- Data is printed, starting from new data to old data.
- Data pointed by a receive buffer write pointer is printed in bold type.

Size of receive buffer

|              |                         |
|--------------|-------------------------|
| RS-232C:     | 1 MB (Max. 65536 lines) |
| Centronics:  | 1 MB (Max. 65536 lines) |
| Network I/F: | 1 MB (Max. 65536 lines) |
| BASIC1:      | 8 KB (Max. 512 lines)   |
| BASIC2:      | 8 KB (Max. 512 lines)   |
| USB:         | 1 MB (Max. 65536 lines) |
| RFID:        | 8 KB (Max. 512 lines)   |

**NOTES:**

1. *To print all data in a receive buffer, the following label length is required.*

|              |         |
|--------------|---------|
| RS-232C:     | 198.2 m |
| Centronics:  | 198.2 m |
| Network I/F: | 198.2 m |
| BASIC1:      | 2 m     |
| BASIC2:      | 2 m     |
| USB:         | 198.2 m |
| RFID:        | 2 m     |

2. *If an error occurs during printing in receive buffer dump mode, the printer displays an error message, then stops. The error is cleared by pressing the [PAUSE] key, and the display is returned to the receive buffer dumping menu "<4> DUMP MODE". After the error is cleared, data is not automatically reprinted.*

## 5.10 BASIC EXPANSION MODE

It is possible to execute the BASIC expansion mode program in BASIC expansion mode under the following conditions:

- The BASIC expansion mode program has already been loaded.
- The BASIC enable setting mode is selected.

The basic expansion mode ends when the basic expansion program is exited.

## 5.11 AUTOMATIC CALIBRATION SETTING

### 5.11.1 Operation Example of Automatic Calibration Setting

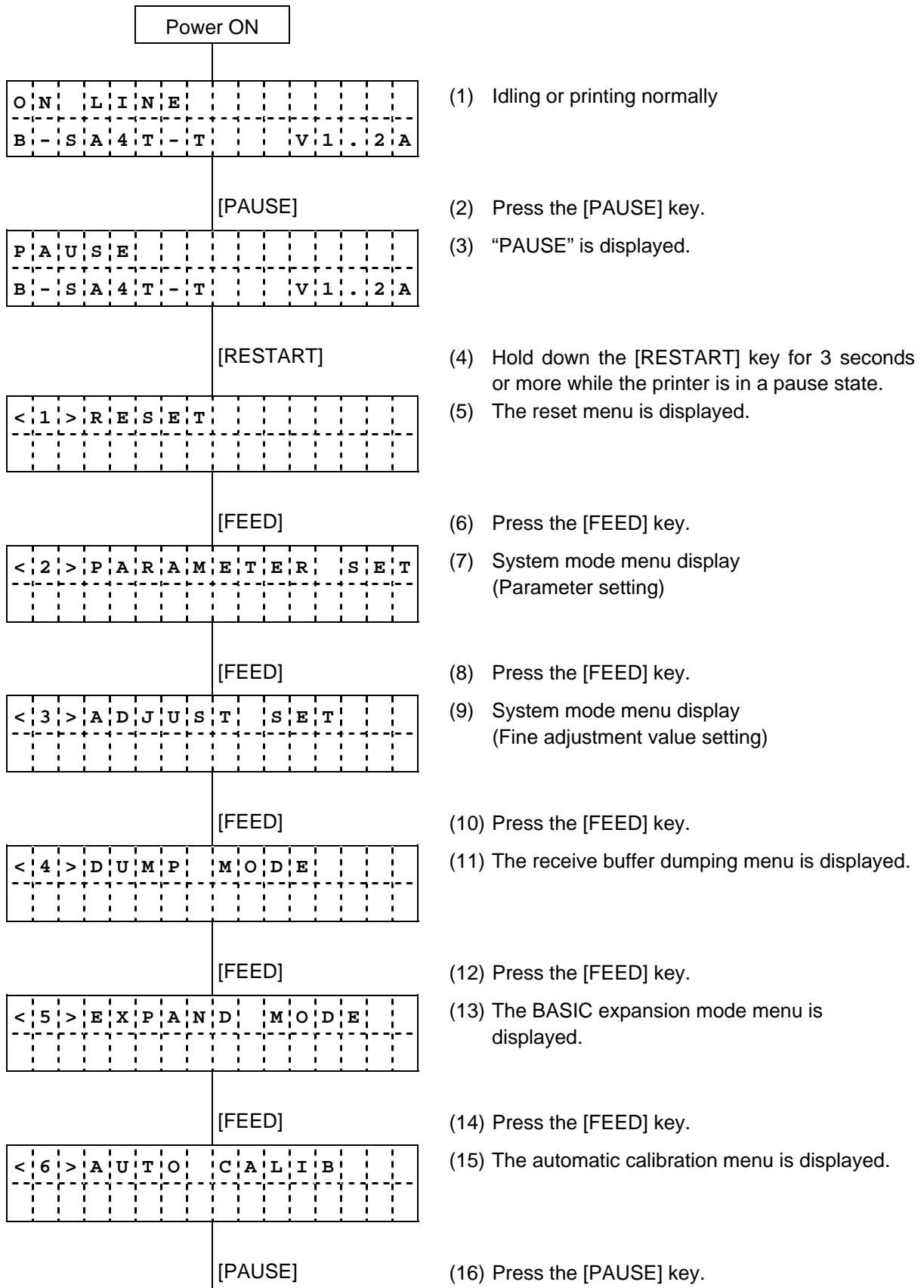

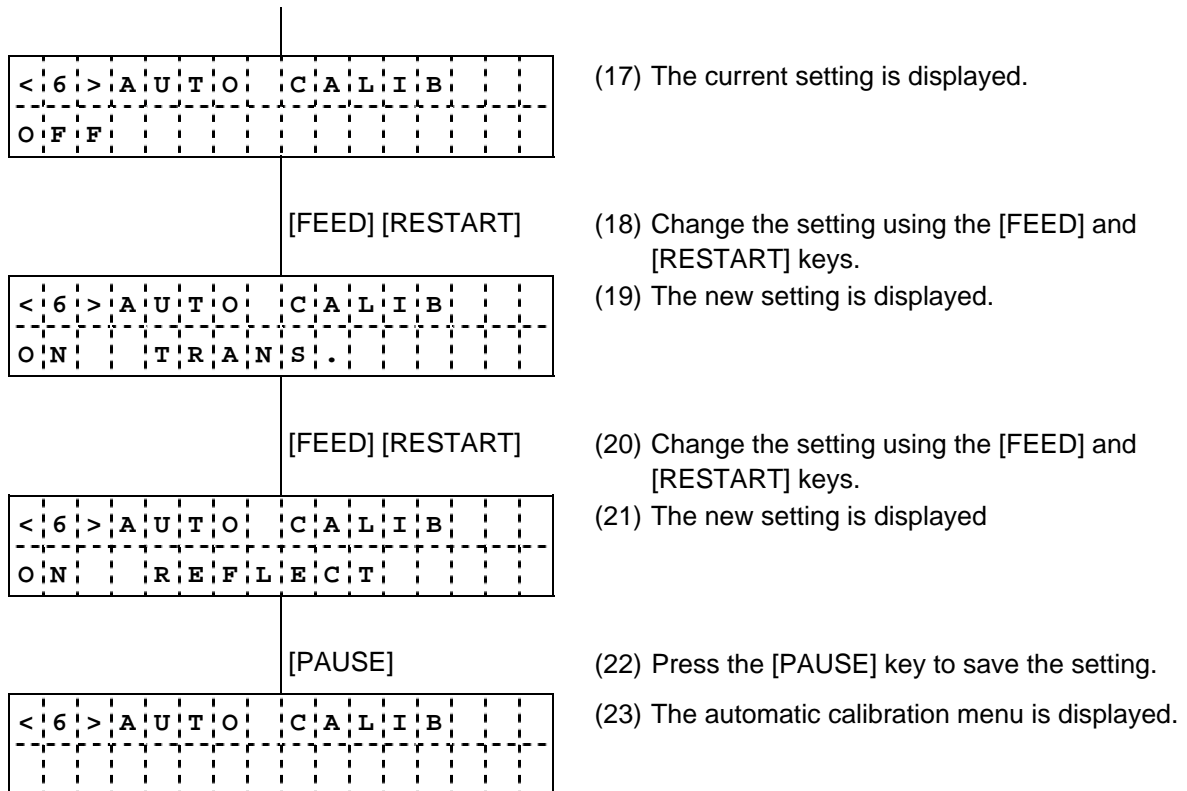

Automatic calibration setting (AUTO CALIB)

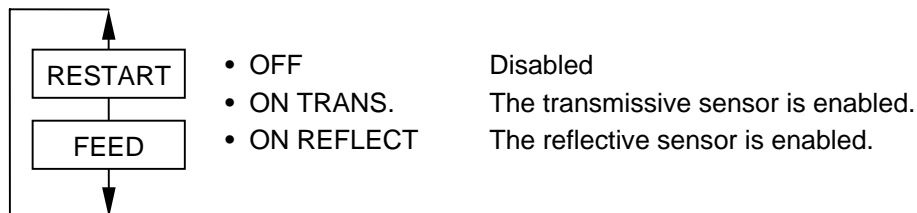

Explanation of operation

- (1) When AUTO CALIB is enabled, automatic calibration starts at open/close of the head after the power is turned on.
- (2) When AUTO CALIB is enabled, operation parameters specified by commands, including paper length, effective print length, and sensor type, are ignored.
- (3) When ON REFLECT is selected, an area of the lowest sensor input value is regarded as a black mark. A threshold value for the black mark is determined by adding a reflective sensor's finely adjusted manual threshold value to the lowest input value.
- (4) When ON TRANS. is selected, an area of the highest sensor input value is regarded as a gap. A threshold value for the gap is determined by deducting a transmissive sensor's finely adjusted manual threshold value from the highest input value.
- (5) Samples of the sensor input value are taken until paper is fed 160.0 mm after the start of operation and the threshold value is determined. If two or more black marks/gaps have been found, the paper length is calculated and the paper feed stops having 1 mm distance to the trailing edge of a measured black mark/gap.

- (6) If the second black mark/gap has not been found under the above conditions, the paper feed continues. If the second black mark/gap is not found even after paper is fed at a maximum of 500 mm, it is regarded as a paper feed jam and the paper feed stops.
- (7) Paper pitch to be supported is 10.0 mm to 150.0 mm.
- (8) When the cutter is installed and a previous issue was performed in cut issue mode, paper is cut and ejected after automatic calibration completes.
- (9) When the automatic calibration is in operation, paper does not stop at a strip position even in strip or special strip mode.
- (10) When the automatic calibration is in operation, a label end error or head open error causes the printer to stop. Opening the head can clear the error and the automatic calibration resumes.
- (11) Whenever the automatic calibration is in operation, the ribbon is driven. Even when a no ribbon state is detected, it does not cause a ribbon error. No ribbon is included in the operation conditions after the automatic calibration completes.

## 5.12 LAN ENABLE/DISABLE SETTING

### 5.12.1 Operation Example of LAN Enable/Disable Setting

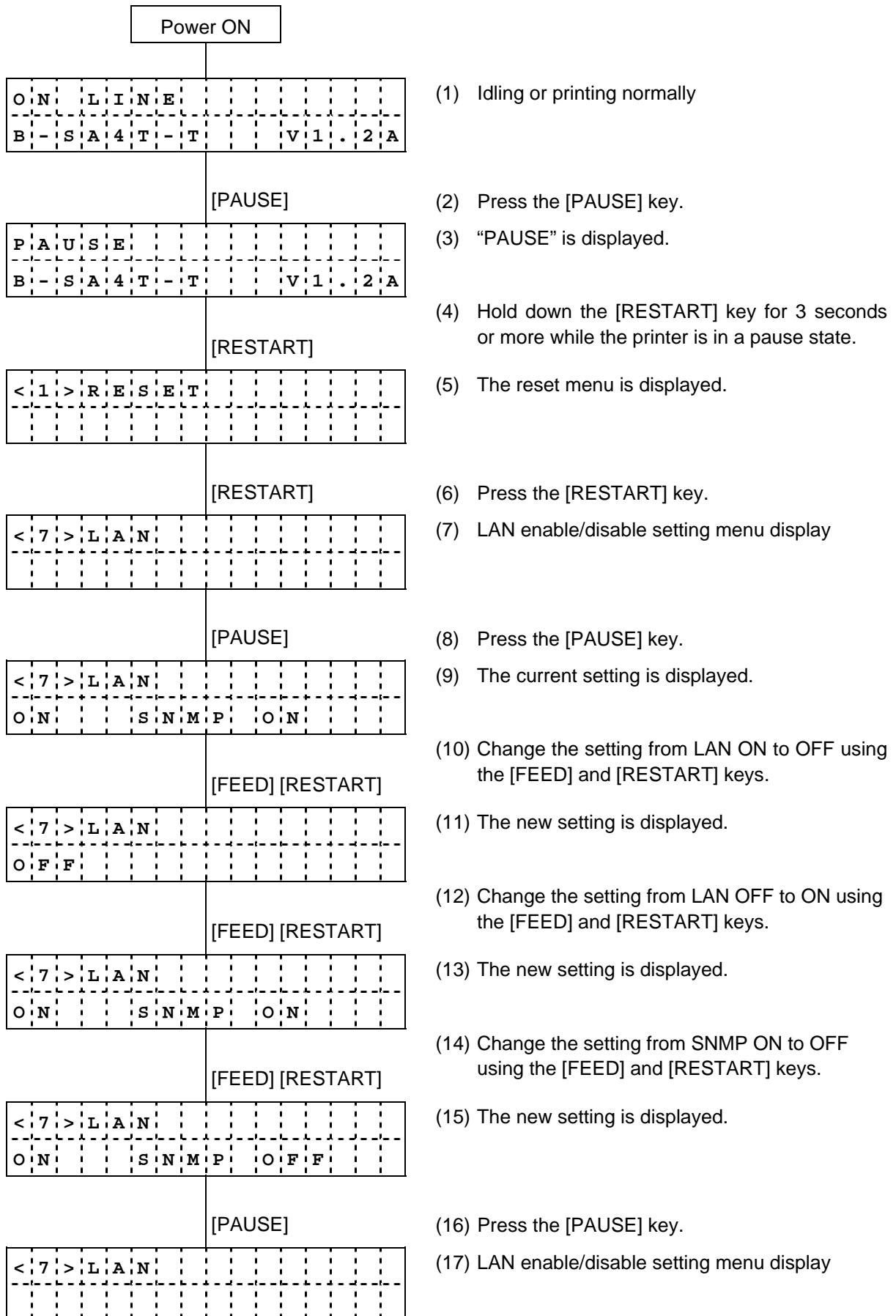

LAN Enable/Disable Setting (LAN)

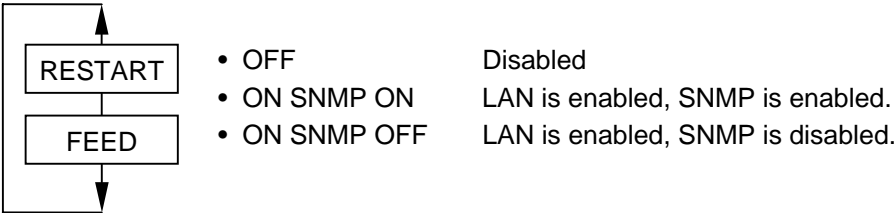

## 5.13 REAL TIME CLOCK (RTC) SETTING

### 5.13.1 Operation Example of RTC Setting

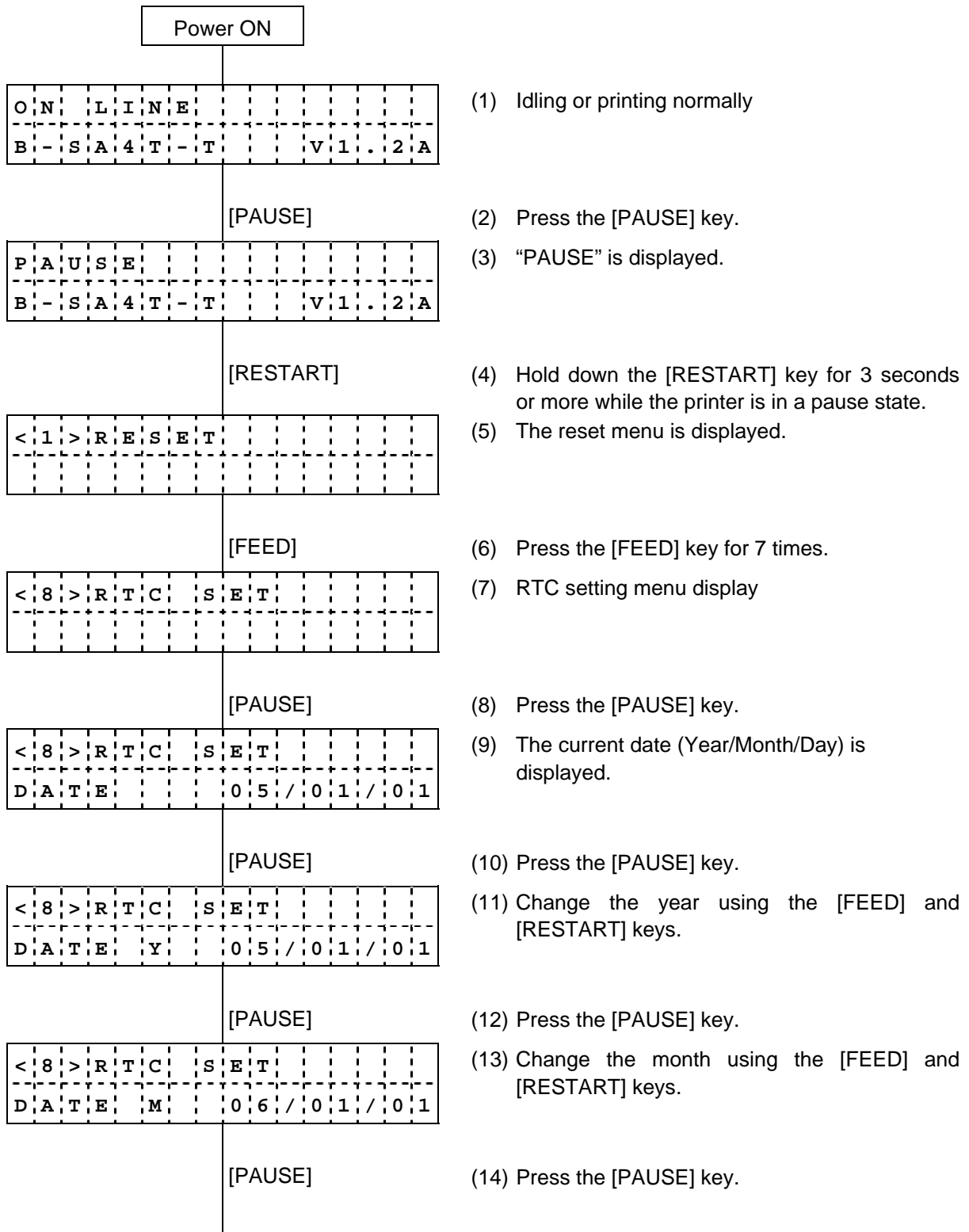

|   |   |   |   |   |   |   |   |   |   |   |   |   |   |  |
|---|---|---|---|---|---|---|---|---|---|---|---|---|---|--|
| < | 8 | > | R | T | C | S | E | T |   |   |   |   |   |  |
| D | A | T | E | D |   | 0 | 5 | / | 0 | 3 | / | 0 | 1 |  |

(15) Change the day using the [FEED] and [RESTART] keys.

[PAUSE]

(16) Press the [PAUSE] key to save the setting.

|   |   |   |   |   |   |   |   |   |   |   |   |   |   |  |
|---|---|---|---|---|---|---|---|---|---|---|---|---|---|--|
| < | 8 | > | R | T | C | S | E | T |   |   |   |   |   |  |
| T | I | M | E |   |   | 0 | 0 | / | 0 | 0 | / | 0 | 0 |  |

(17) The current time is displayed.

[PAUSE]

(18) Press the [PAUSE] key.

|   |   |   |   |   |   |   |   |   |   |   |   |   |   |  |
|---|---|---|---|---|---|---|---|---|---|---|---|---|---|--|
| < | 8 | > | R | T | C | S | E | T |   |   |   |   |   |  |
| T | I | M | E | H |   | 0 | 0 | / | 0 | 0 | / | 0 | 0 |  |

(19) Change the hour using the [FEED] and [RESTART] keys.

[PAUSE]

(20) Press the [PAUSE] key.

|   |   |   |   |   |   |   |   |   |   |   |   |   |   |  |
|---|---|---|---|---|---|---|---|---|---|---|---|---|---|--|
| < | 8 | > | R | T | C | S | E | T |   |   |   |   |   |  |
| T | I | M | E | M |   | 0 | 0 | / | 0 | 0 | / | 0 | 0 |  |

(21) Change the minute using the [FEED] and [RESTART] keys.

[PAUSE]

(22) Press the [PAUSE] key.

|   |   |   |   |   |   |   |   |   |   |   |   |   |   |  |
|---|---|---|---|---|---|---|---|---|---|---|---|---|---|--|
| < | 8 | > | R | T | C | S | E | T |   |   |   |   |   |  |
| T | I | M | E | S |   | 0 | 0 | / | 0 | 0 | / | 0 | 0 |  |

(23) Change the second using the [FEED] and [RESTART] keys.

[PAUSE]

(24) Press the [PAUSE] key to save the setting.

|   |   |   |   |   |   |   |   |   |   |   |   |   |   |  |
|---|---|---|---|---|---|---|---|---|---|---|---|---|---|--|
| < | 8 | > | R | T | C | S | E | T |   |   |   |   |   |  |
| L | O | W | B | A | T | T | . |   | C | H | E | C | K |  |

(25) The low battery check setting menu is displayed.

[PAUSE]

(26) Press the [PAUSE] key.

|   |   |   |   |   |   |   |   |   |  |  |  |   |   |   |
|---|---|---|---|---|---|---|---|---|--|--|--|---|---|---|
| < | 8 | > | R | T | C | S | E | T |  |  |  |   |   |   |
| L | O | W | B | A | T | T | . |   |  |  |  | O | F | F |

(27) The current setting is displayed.  
Change the setting using the [FEED] and [RESTART] keys.

[PAUSE]

(28) Press the [PAUSE] key to save the setting.

|   |   |   |   |   |   |   |   |   |  |  |  |  |  |  |
|---|---|---|---|---|---|---|---|---|--|--|--|--|--|--|
| < | 8 | > | R | T | C | S | E | T |  |  |  |  |  |  |
| R | E | N | E | W | A | L |   |   |  |  |  |  |  |  |

(29) The RTC data renewal timing setting menu is displayed.

[PAUSE]

(30) Press the [PAUSE] key.

|   |   |   |   |   |   |   |   |   |  |  |   |   |   |   |   |
|---|---|---|---|---|---|---|---|---|--|--|---|---|---|---|---|
| < | 8 | > | R | T | C | S | E | T |  |  |   |   |   |   |   |
| R | E | N | E | W | A | L |   |   |  |  | B | A | T | C | H |

(31) The current setting is displayed.  
Change the setting using the [FEED] and [RESTART] keys.

[PAUSE]

(32) Press the [PAUSE] key to save the setting.



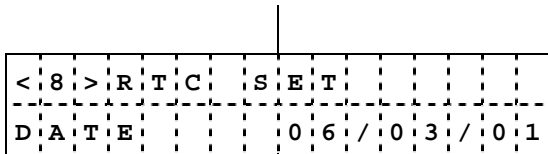

(33) The current date is displayed.

[FEED] [RESTART]

(34) Press the [FEED] and [RESTART] keys.

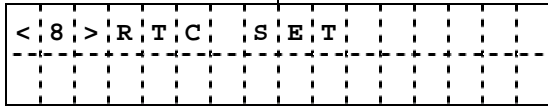

(35) The RTC setting menu is displayed.

#### RTC low battery check (LOWBATT. CHECK)

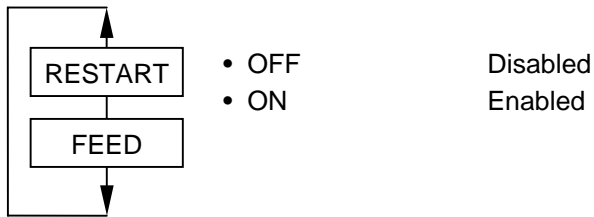

#### RTC data renewal timing (RENEWAL)

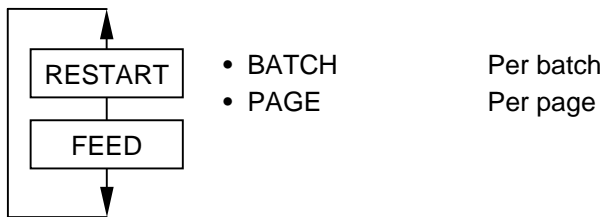

#### NOTES:

- Be sure to load the battery whenever the RTC data is used.
- If the battery is not loaded or the battery voltage is low, the RTC data is erased at the power off time.
- When the low battery check function is set to ON, the printer stops at the power on time due to a "LOW BATTERY" error if the battery voltage is 1.9V or less. As a restart is invalidated in this case, hold down the [RESTART] key to cause the printer to enter <1>RESET mode, access the Real Time Clock setting mode, and set the low battery function to OFF.
- The factory setting for the low battery check function is OFF.
- To enable the real time clock function, set the low battery check to ON.
- When the low battery check is set to OFF, the RTC function is available even in a low battery state. However, the setting and check of the real time clock is required whenever the power is turned on.
- When the RTC data renewal timing is set to "PAGE", the printer stops between labels ignoring the on-the-fly issue even when an Issue command is sent to print more than one label.

## 5.14 BASIC SETTING

### 5.14.1 Operation Example of BASIC Setting

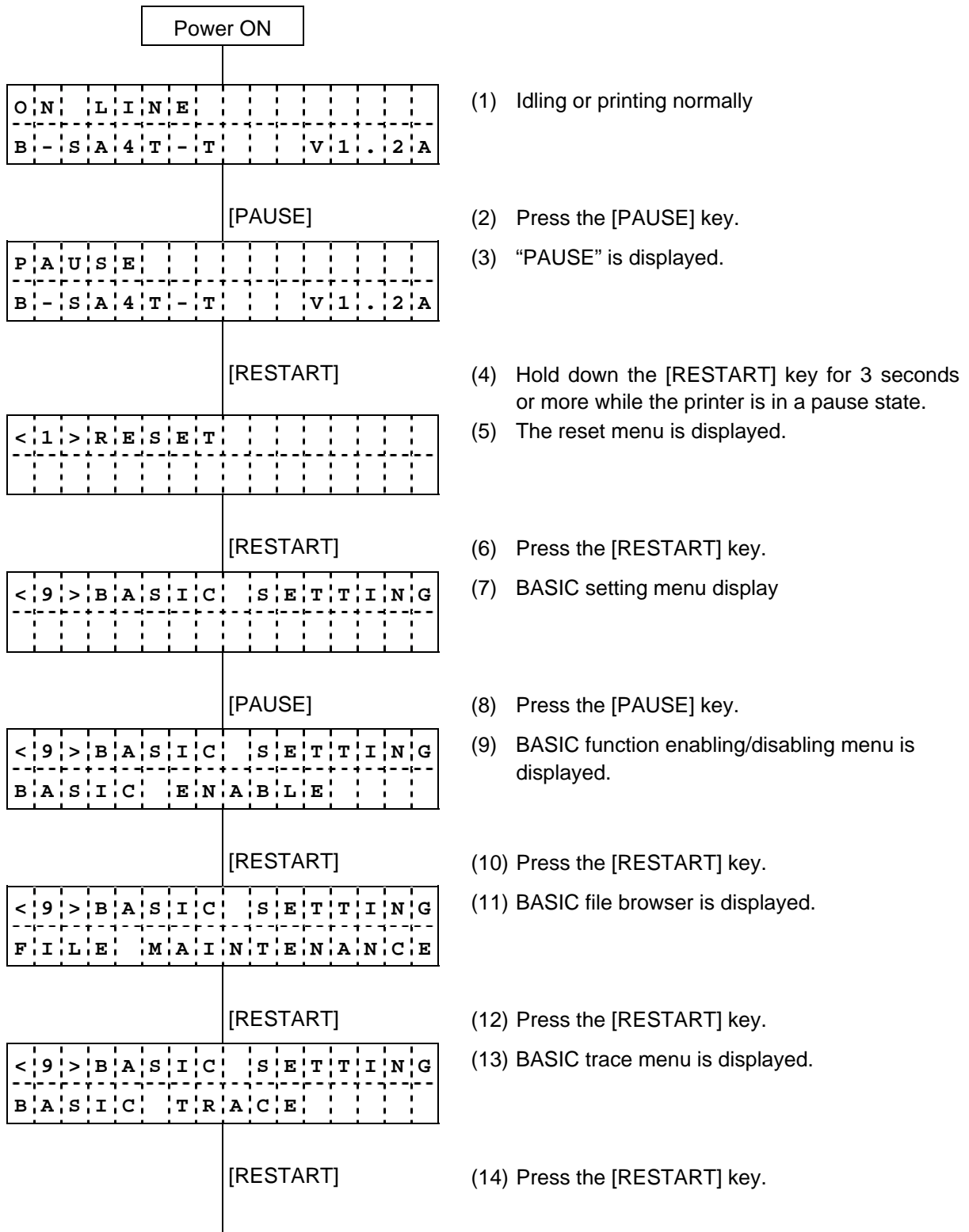

```
< 9 > B A S I C   S E T T I N G
E X P A N D   M O D E
```

(15) BASIC expansion menu is displayed.

[RESTART]

(16) Press the [RESTART] key.

```
< 9 > B A S I C   S E T T I N G
B A S I C   E N A B L E
```

(17) BASIC function enable/disable setting menu is displayed.

[PAUSE]

(18) Press the [PAUSE] key.

```
< 9 > B A S I C   S E T T I N G
B A S I C           O F F
```

(19) BASIC function is disabled.

[FEED]

(20) Press the [FEED] key.

```
< 9 > B A S I C   S E T T I N G
B A S I C           O N
```

(21) BASIC function is enabled.

[PAUSE]

(22) Press the [PAUSE] key.

```
< 9 > B A S I C   S E T T I N G
F I L E   M A I N T E N A N C E
```

(23) BASIC file browser is displayed.

[PAUSE]

(24) Press the [PAUSE] key to save the setting.

```
< 9 > B A S I C   S E T T I N G
0 0   T E S T . B A S
```

(25) Program file is displayed.

[RESTART]

(26) Press the [RESTART] key.

```
< 9 > B A S I C   S E T T I N G
0 1   T E S T . D A T
```

(27) Data file is displayed.

(28) Names of data files in the BASIC file area are displayed.

```
< 9 > B A S I C   S E T T I N G
0 0   T E S T . B A S
```

(29) Program file is displayed.

[PAUSE]

(30) Press the [PAUSE] key.

```
< 9 > B A S I C   S E T T I N G
B A S I C   T R A C E
```

(31) BASIC trace menu is displayed.

[PAUSE]

(32) Press the [PAUSE] key.

|   |   |   |   |   |   |   |   |   |   |   |   |   |   |   |
|---|---|---|---|---|---|---|---|---|---|---|---|---|---|---|
| < | 9 | > | B | A | S | I | C | S | E | T | T | I | N | G |
| T | R | A | C | E |   |   |   | O | F | F |   |   |   |   |

(33) BASIC trace function is disabled.

[FEED]

(34) Press the [FEED] key.

|   |   |   |   |   |   |   |   |   |   |   |   |   |   |   |
|---|---|---|---|---|---|---|---|---|---|---|---|---|---|---|
| < | 9 | > | B | A | S | I | C | S | E | T | T | I | N | G |
| T | R | A | C | E |   |   |   | O | N |   |   |   |   |   |

(35) BASIC trace function is enabled.

[PAUSE]

(36) Press the [PAUSE] key.

|   |   |   |   |   |   |   |   |   |   |   |   |   |   |   |
|---|---|---|---|---|---|---|---|---|---|---|---|---|---|---|
| < | 9 | > | B | A | S | I | C | S | E | T | T | I | N | G |
| E | X | P | A | N | D |   |   | M | O | D | E |   |   |   |

(37) BASIC expansion menu is displayed.

[PAUSE]

(38) When the program for the BASIC expansion mode has been loaded, it will be executed by pressing the [PAUSE] key.

How to exit the program depends on the program for the BASIC expansion mode.

|   |   |   |   |   |   |   |   |   |   |   |   |   |   |   |
|---|---|---|---|---|---|---|---|---|---|---|---|---|---|---|
| < | 9 | > | B | A | S | I | C | S | E | T | T | I | N | G |
|   |   |   |   |   |   |   |   |   |   |   |   |   |   |   |

(39) BASIC setting menu display

## 5.15 LCD MESSAGES AND LED INDICATIONS

The model, the print head type, and firmware version are displayed on the lower line of the LCD.

| No. | LCD Messages on Upper line (English)   | LED Indication |       | Printer Status  | Recoverable by the [RESTART] key Yes/No | Acceptance of Status Request and Reset Commands Yes/No |
|-----|--|----------------|-------|---|---|--|
|     |  | ON LINE        | ERROR |   |   |  |
| 1   | ON LINE                                | ○              | ●     | Online mode   | -                                       | Yes  |
|     | ON LINE                                | ⊙              | ●     | Online mode (Communicating)   | -                                       | Yes  |
| 2   | HEAD OPEN                              | ●              | ●     | The head was opened in online mode.   | -                                       | Yes  |
| 3   | PAUSE ****                             | ●              | ●     | Pause state   | Yes                                     | Yes  |
| 4   | COMMS ERROR                            | ●              | ○     | A parity error or a framing error occurred during communication by RS-232C.   | Yes                                     | Yes  |
| 5   | PAPER JAM ****                         | ●              | ○     | A paper jam occurred during paper feed.   | Yes                                     | Yes  |
| 6   | CUTTER ERROR****                       | ●              | ○     | An abnormal condition occurred at the cutter.   | Yes                                     | Yes  |
| 7   | NO PAPER ****                          | ●              | ○     | The label has run out.  | Yes                                     | Yes  |
| 8   | HEAD OPEN ****                         | ●              | ○     | A feed or an issue was attempted with the head opened. (except when the [FEED] key is pressed or in expansion I/O operation mode) | Yes                                     | Yes  |
| 9   | HEAD ERROR                             | ●              | ○     | A broken dot error occurred in the thermal head.  | Yes                                     | Yes  |
| 10  | EXCESS HEAD TEMP                       | ●              | ○     | The thermal head temperature is excessively high.   | No                                      | Yes  |
| 11  | RIBBON ERROR****                       | ●              | ○     | The ribbon has run out. An abnormal condition occurred in the sensor used for determining a torque for the ribbon motor.          | Yes                                     | Yes  |
| 12  | COVER OPEN ****                        | ●              | ○     | A feed or an issue was attempted with the front cover opened.   | Yes                                     | Yes  |
| 13  | SAVING ##### &&&&                      | ○              | ●     | In writable character or PC command save mode   | -                                       | Yes  |
| 14  | FLASH WRITE ERR.                       | ●              | ○     | An error occurred in writing data into memory for storage (flash ROM on the CPU board).   | No                                      | Yes  |
| 15  | FORMAT ERROR                           | ●              | ○     | An error occurred in formatting memory for storage (flash ROM on the CPU board).  | No                                      | Yes  |
| 16  | FLASH CARD FULL                        | ●              | ○     | Saving failed because of an insufficient capacity of memory for storage (flash ROM on the CPU board).                             | No                                      | Yes  |
| 17  | Display of error command (See NOTE 1.) | ●              | ○     | A command error occurred in analyzing a command.  | Yes                                     | Yes  |
| 18  | POWER FAILURE                          | ●              | ○     | A momentary power interruption occurred.  | No                                      | No   |

| No. | LCD Messages on Upper line (English) | LED Indication |       | Printer Status  | Recoverable by the [RESTART] key Yes/No | Acceptance of Status Request and Reset Commands Yes/No |
|-----|--------------------------------------|----------------|-------|---|---|--|
|     |                                      | ON LINE        | ERROR |   |   |  |
| 19  | <b>INITIALIZING...</b>               | ●              | ●     | Memory for storage is being initialized. (Initialization is carried out for a maximum of approximately 15 seconds.)   | —                                       | —  |
| 20  | <b>EEPROM ERROR</b>                  | ●              | ○     | Data cannot be read from/written to a backup EEPROM properly.   | No                                      | No   |
| 21  | <b>SYSTEM ERROR</b>                  | ●              | ○     | When the following abnormal operations are performed, a system error occurs:<br>(a) Command fetch from an odd address<br>(b) Access to word data at an odd address<br>(c) Access to long-word data at an odd address<br>(d) Access to the area of 80000000H to FFFFFFFFH in the logic space in user mode.<br>(e) An undefined instruction in an area other than a delay slot was decoded.<br>(f) An undefined instruction in a delay slot was decoded.<br>(g) An instruction to rewrite a delay slot was decoded. | No                                      | No   |
| 22  | <b>100BASE LAN INITIALIZING...</b>   | ●              | ●     | The 100BASE LAN is being initialized.   | —                                       | —  |
| 23  | <b>DHCP CLIENT INITIALIZING...</b>   | ●              | ●     | The DHCP client is being initialized.<br>* When the DHCP function is enabled.   | —                                       | —  |
| 24  | <b>RFID WRITE ERROR</b>              | ●              | ○     | The printer did not succeed in writing data onto an RFID tag after having retried for a specified times.  | Yes                                     | Yes  |
| 25  | <b>RFID ERROR</b>                    | ●              | ○     | The printer cannot communicate with an RFID module.   | Yes                                     | Yes  |
| 26  | <b>LOW BATTERY</b>                   | ●              | ○     | The voltage of the battery connected to the real time clock is approximately 1.9 V or less.   | No                                      | Yes  |

**NOTE 1:** When a command produces an error, 16 bytes of the command code of the erroneous command are displayed on the upper line of the LCD. (However, [LF] and [NUL] are not displayed.)

[Example 1] [ESC] PC001; 0A00, 0300, 2, 2, A, 00, B [LF] [NUL]

└─ Command error

LCD display

|                                    |
|------------------------------------|
| PC001;0A00,0300,<br>B-SA4T-T V1.2A |
|------------------------------------|

[Example 2] [ESC] T20 G30 [LF] [NUL]

└─ Command error

LCD display

|                          |
|--------------------------|
| T20G30<br>B-SA4T-T V1.2A |
|--------------------------|

[Example 3] [ESC] XR; 0200, 0300, 0450, 1200, 1 [LF] [NUL]

└─ Command error

LCD display

|                                    |
|------------------------------------|
| XR;0200,0300,045<br>B-SA4T-T V1.2A |
|------------------------------------|

**NOTE 2:** When a command error is displayed, “? (3FH)” is displayed for codes other than 20H to 7FH and A0H to DFH.

- NOTE 3:**
- : ON
  - ◉: Blinking
  - : OFF
  - \*\*\*\*: Number of remaining labels to be printed      □□□□ to 9999 (in units of 1 label/tag)
  - ###: Remaining memory capacity of PC save area of a flash memory on the CPU:  
0 to 3072 (in K bytes)
  - &&&: Remaining memory capacity of writable character storage area for a flash memory on the CPU  
0 to 3072 (in K bytes)

**NOTE 4:** When a ribbon near end detection setting is enabled, the ERROR LED blinks slowly, while the printer is in a ribbon near end state and displays a message 1, 2, or 3.

## 5.16 LCD MESSAGES IN DIFFERENT LANGUAGES (UPPER LINE ON LCD)

| No. | ENGLISH           |
|-----|-------------------|
| 1   | ON LINE           |
| 2   | HEAD OPEN         |
| 3   | PAUSE ****        |
| 4   | COMMS ERROR       |
| 5   | PAPER JAM ****    |
| 6   | CUTTER ERROR****  |
| 7   | NO PAPER ****     |
| 8   | HEAD OPEN ****    |
| 9   | HEAD ERROR        |
| 10  | EXCESS HEAD TEMP  |
| 11  | RIBBON ERROR****  |
| 12  | COVER OPEN ****   |
| 13  | SAVING ##### &&&& |
| 14  | FLASH WRITE ERR.  |
| 15  | FORMAT ERROR      |
| 16  | FLASH CARD FULL   |
| 17  | INITIALIZING...   |
| 18  | POWER FAILURE     |
| 19  | EEPROM ERROR      |
| 20  | SYSTEM ERROR      |
| 21  | RFID WRITE ERROR  |
| 22  | RFID ERROR        |
| 23  | LOW BATTERY       |

| No. | GERMAN             |
|-----|--------------------|
| 1   | ON LINE            |
| 2   | KOPF OFFEN         |
| 3   | PAUSE ****         |
| 4   | UEBERTR.-FEHLER    |
| 5   | PAPIERSTAU ****    |
| 6   | MESSERFEHL. ****   |
| 7   | PAPIERENDE ****    |
| 8   | KOPF OFFEN ****    |
| 9   | KOPF DEFECT        |
| 10  | KOPF UEBERHITZT    |
| 11  | FB-FEHLER ****     |
| 12  | DECKEL OFFEN****   |
| 13  | SP.-MOD ##### &&&& |
| 14  | FLASH FEHLER       |
| 15  | FORMATFEHLER       |
| 16  | FLASH ZU KLEIN     |
| 17  | INITIALIZING...    |
| 18  | POWER FAILURE      |
| 19  | EEPROM ERROR       |
| 20  | SYSTEM ERROR       |
| 21  | RFID WRITE ERROR   |
| 22  | RFID ERROR         |
| 23  | LOW BATTERY        |

| No. | FRENCH             |
|-----|--------------------|
| 1   | PRETE              |
| 2   | TETE OUVERTE       |
| 3   | PAUSE ****         |
| 4   | ERR. COMMUNICAT.   |
| 5   | PB. PAPIER ****    |
| 6   | PB. CUTTER ****    |
| 7   | FIN PAPIER ****    |
| 8   | TETE OUVERTE****   |
| 9   | ERREUR TETE        |
| 10  | TETE TROP CHAUDE   |
| 11  | ERREUR RUBAN****   |
| 12  | ERR.CAPOT ****     |
| 13  | MEM LIB ##### &&&& |
| 14  | ERREUR MEM FLASH   |
| 15  | ERREUR DE FORMAT   |
| 16  | MEM INSUFFISANTE   |
| 17  | INITIALIZING...    |
| 18  | POWER FAILURE      |
| 19  | EEPROM ERROR       |
| 20  | SYSTEM ERROR       |
| 21  | RFID WRITE ERROR   |
| 22  | RFID ERROR         |
| 23  | LOW BATTERY        |

| No. | DUTCH            |
|-----|------------------|
| 1   | IN LIJN          |
| 2   | KOP OPEN         |
| 3   | PAUZE ****       |
| 4   | COMM. FOUT       |
| 5   | PAPIER VAST **** |
| 6   | SNIJMES FOUT**** |
| 7   | PAPIER OP ****   |
| 8   | KOP OPEN ****    |
| 9   | PRINTKOP DEFECT  |
| 10  | TEMP. FOUT       |
| 11  | LINT FOUT ****   |
| 12  | DEUR OPEN ****   |
| 13  | MEM ##### &&&&   |
| 14  | FLASH MEM FOUT   |
| 15  | FORMAAT FOUT     |
| 16  | GEHEUGEN VOL     |
| 17  | INITIALIZING...  |
| 18  | POWER FAILURE    |
| 19  | EEPROM ERROR     |
| 20  | SYSTEM ERROR     |
| 21  | RFID WRITE ERROR |
| 22  | RFID ERROR       |
| 23  | LOW BATTERY      |

| No. | SPANISH           |
|-----|-------------------|
| 1   | ON LINE           |
| 2   | CABEZAL ABIERTO   |
| 3   | PAUSA ****        |
| 4   | ERROR COMUNICACI  |
| 5   | ATASCO PAPEL****  |
| 6   | ERROR CORTAD****  |
| 7   | SIN PAPEL ****    |
| 8   | CABEZA ABIER****  |
| 9   | ERROR DE CABEZAL  |
| 10  | TEMP.CABEZA ALTA  |
| 11  | ERROR CINTA ****  |
| 12  | TAPA ABIERTA****  |
| 13  | SALVAR ##### &&&& |
| 14  | ERROR ESCRITURA   |
| 15  | ERROR DE FORMATO  |
| 16  | MEMORIA INSUFICI  |
| 17  | INITIALIZING...   |
| 18  | POWER FAILURE     |
| 19  | EEPROM ERROR      |
| 20  | SYSTEM ERROR      |
| 21  | RFID WRITE ERROR  |
| 22  | RFID ERROR        |
| 23  | LOW BATTERY       |

| No. | JAPANESE |
|-----|----------|
| 1   |          |
| 2   |          |
| 3   |          |
| 4   |          |
| 5   |          |
| 6   |          |
| 7   |          |
| 8   |          |
| 9   |          |
| 10  |          |
| 11  |          |
| 12  |          |
| 13  |          |
| 14  |          |
| 15  |          |
| 16  |          |
| 17  |          |
| 18  |          |
| 19  |          |
| 20  |          |
| 21  |          |
| 22  |          |
| 23  |          |

\* Japanese messages are omitted here.



| No. | Italian          |
|-----|------------------|
| 1   | PRONTA           |
| 2   | TESTA APERTA     |
| 3   | PAUSA ****       |
| 4   | ERR. COMUNICAZ.  |
| 5   | CARTA INCEP.**** |
| 6   | ERR. TAGL. ****  |
| 7   | NO CARTA ****    |
| 8   | TESTA APERTA**** |
| 9   | ERROR TESTA      |
| 10  | TEMP. TESTA ALTA |
| 11  | ERR. NASTRO **** |
| 12  | COVER OPEN ****  |
| 13  | SALVA ##### &&&  |
| 14  | ERR.SCRITT.CARD  |
| 15  | ERR. FORMATTAZ.  |
| 16  | MEM. CARD PIENA  |
| 17  | INITIALIZING...  |
| 18  | POWER FAILURE    |
| 19  | EEPROM ERROR     |
| 20  | SYSTEM ERROR     |
| 21  | RFID WRITE ERROR |
| 22  | RFID ERROR       |
| 23  | LOW BATTERY      |

## 6. SYSTEM MODE

### 6.1 OUTLINE OF SYSTEM MODE

In this mode, self-test and parameter settings are performed. Described below is the key operation procedure in system mode.

- System mode for service persons and system administrators (All menu items are available.)

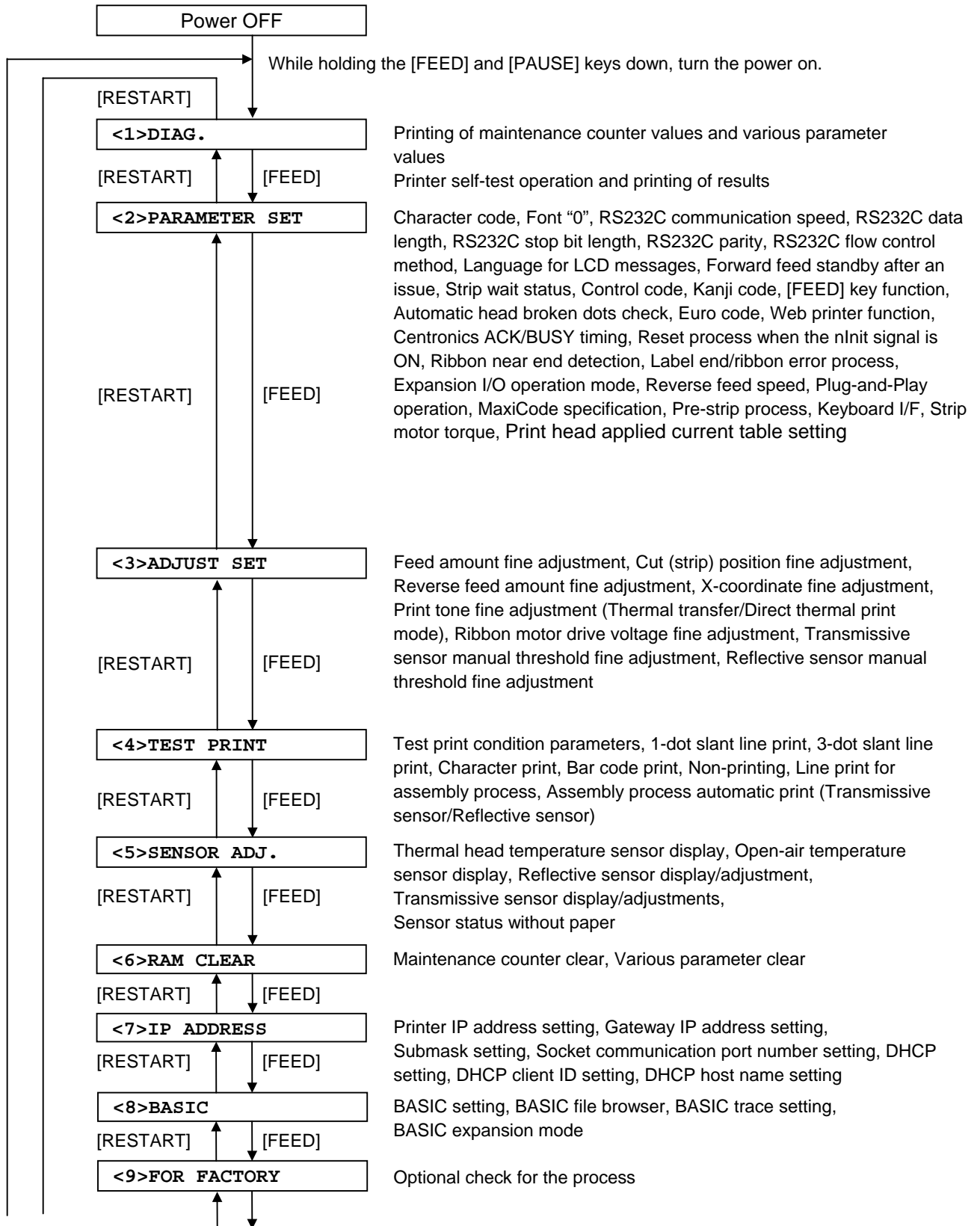

Continued on the following page.

Continued from the previous page.

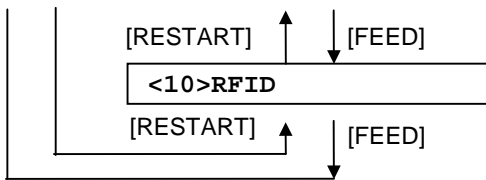

RFID read test, RFID module type, Carrier sense (Not available to B-SA704-RFID-U2-EU-R), RFID tag type, RFID error tag detection, Maximum number of issue retries, Maximum number of read retries, Read retry time-out, Maximum number of write retries, Write retry time-out, RFID adjustment for retry, RFID output power level, AGC threshold, RFID channel (Not available to B-SA704-RFID-U2-EU-R), Q value, AGC threshold for data write, AGC threshold lower limit for retry

●System mode for users (Available menu items are limited.)

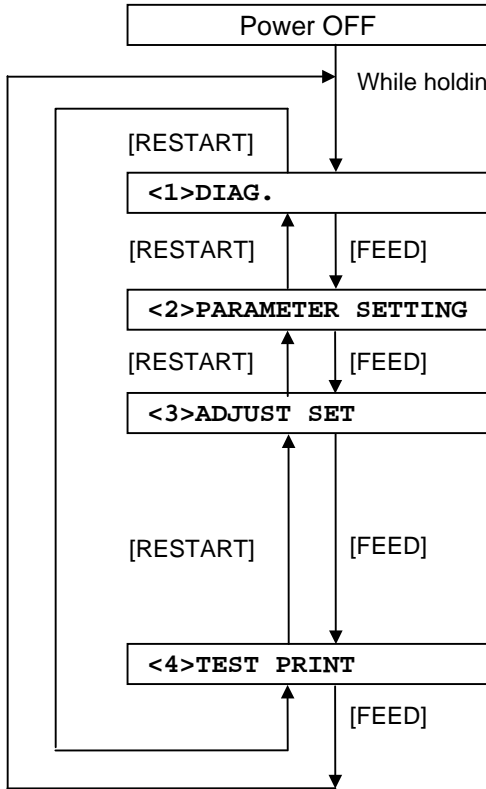

While holding the [FEED] and [RESTART] keys down, turn the power on.

Printing of maintenance counter values and various parameter values  
Printer self-test operation and printing of results

Feed amount fine adjustment, Cut (strip) position fine adjustment, Reverse feed amount fine adjustment, X-coordinate fine adjustment, Print tone fine adjustment (Thermal transfer/Direct thermal print mode), Ribbon motor drive voltage fine adjustment, Transmissive sensor manual threshold fine adjustment, Reflective sensor manual threshold fine adjustment

Test print condition parameters, 1-dot slant line print, 3-dot slant line print, Character print, Bar code print, Non-printing, Line print for assembly process, Assembly process automatic print (Transmissive sensor/Reflective sensor)

## 6.2 SELF-TEST

### 6.2.1 Self-test Operation Example

- (1) Printing of maintenance counter values, various parameter values, and automatic self-test result

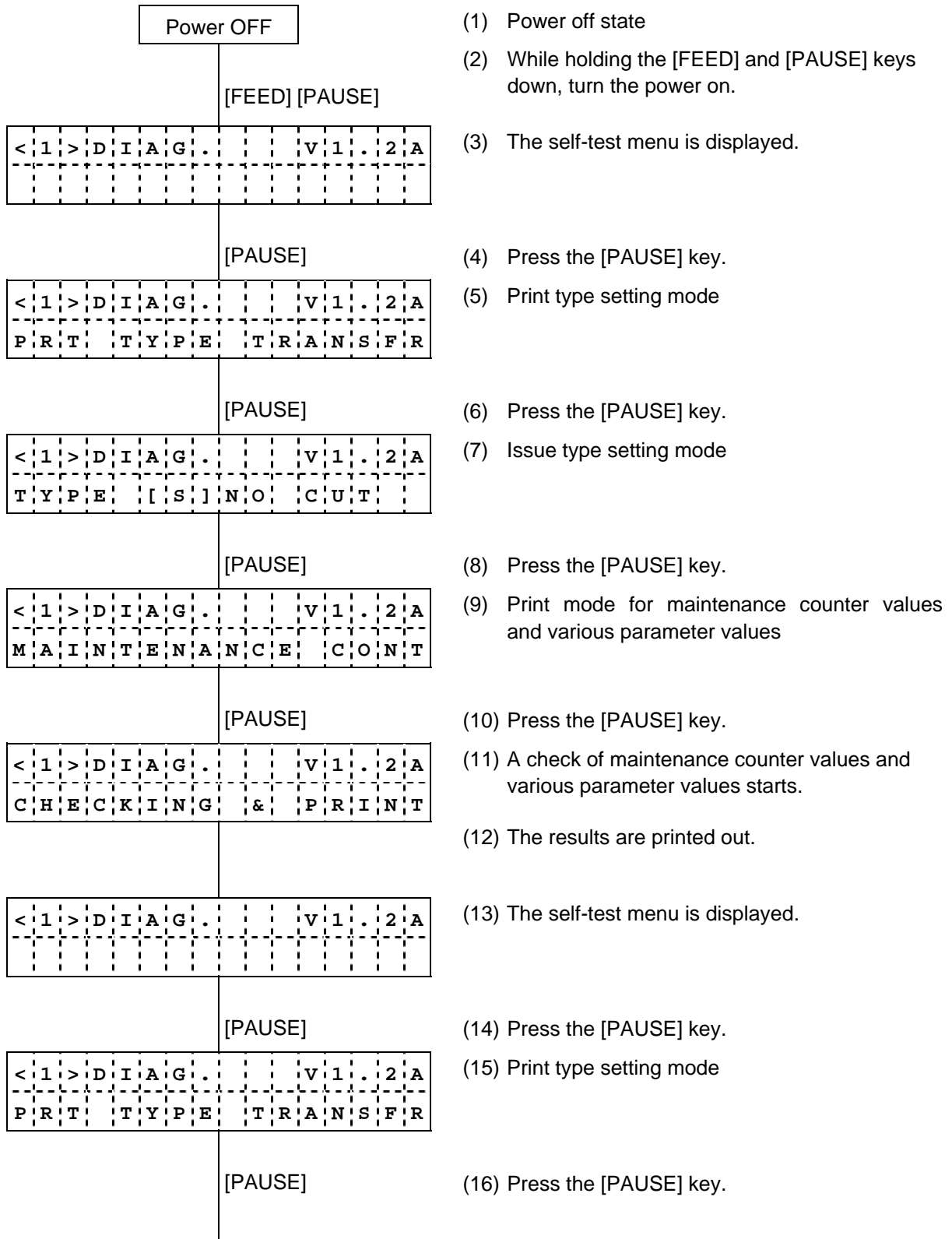

```

< 1 > D I A G . . . V 1 . . 2 A
-----
T Y P E [ S ] N O C U T

```

(17) Issue type setting mode

[PAUSE]

(18) Press the [PAUSE] key.

```

< 1 > D I A G . . . V 1 . . 2 A
-----
A U T O D I A G N O S T I C

```

(19) Automatic self-test mode

[PAUSE]

(20) Press the [PAUSE] key.

```

< 1 > D I A G . . . V 1 . . 2 A
-----
C H E C K I N G & P R I N T

```

(21) Start of automatic self-test

(22) The results are printed out.

```

< 1 > D I A G . . . V 1 . . 2 A
-----

```

(23) The self-test menu is displayed.

Print type (PRT TYPE)

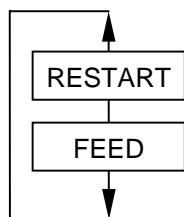

- TRANSFR
- DIRECT

(Thermal transfer printing)  
(Direct thermal printing)

Issue type (TYPE)

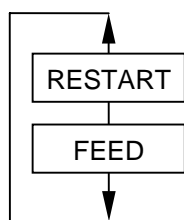

- [S]NO CUT
- [C]WITH CUT

(Batch issue)  
(Issue with a cut)

**NOTE:** When an error occurs while printing the result of a self-test, an error message is displayed and printing stops. The error is cleared by pressing the [PAUSE] key, then the system mode menu is displayed again. Printing is not automatically resumed after the error is cleared.

(2) Head broken dots check

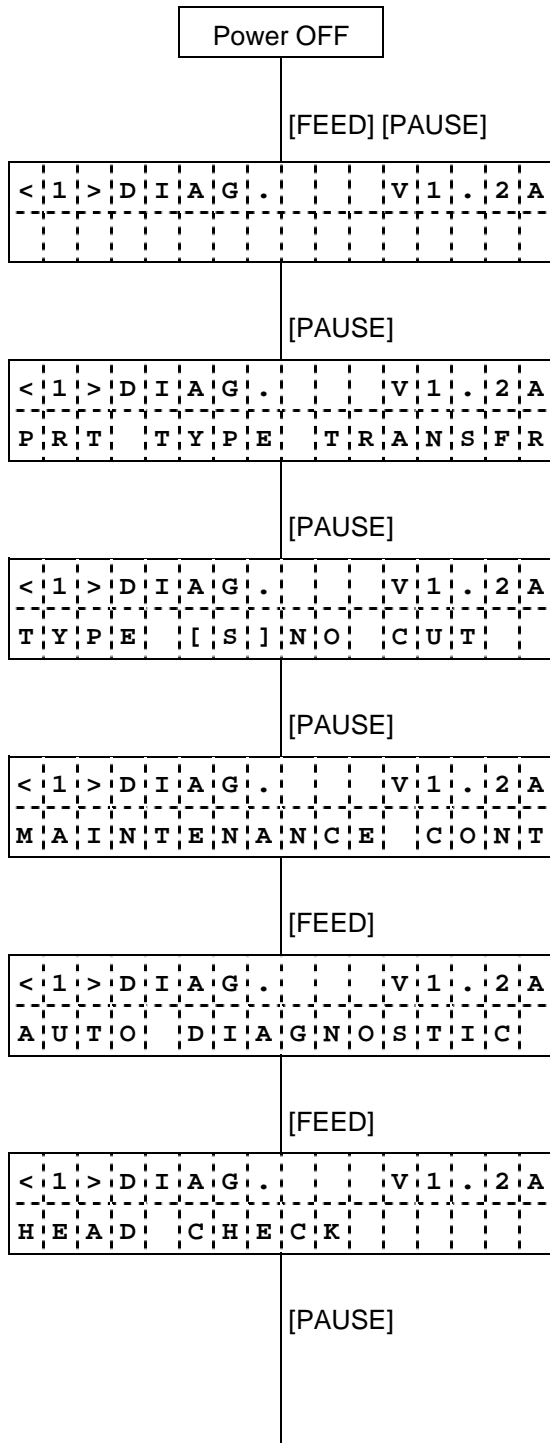

- (1) Power off state
- (2) While holding the [FEED] and [PAUSE] keys down, turn the power on.
- (3) The self-test menu is displayed.
- (4) Press the [PAUSE] key.
- (5) Print type setting mode
- (6) Press the [PAUSE] key.
- (7) Issue type setting mode
- (8) Press the [PAUSE] key.
- (9) Print mode for maintenance counter values and various parameter values
- (10) Press the [FEED] key.
- (11) Automatic self-test mode
- (12) Press the [FEED] key.
- (13) Head broken dots check mode
- (14) Press the [PAUSE] key.

|   |   |   |   |   |   |   |   |   |   |   |   |   |   |   |   |
|---|---|---|---|---|---|---|---|---|---|---|---|---|---|---|---|
| < | 1 | > | D | I | A | G | . | . | . | . | V | 1 | . | 2 | A |
| C | H | E | C | K | I | N | G | . | . | . | . | . | . | . | . |

(15) Start of head broken dots check

[When a broken dot error is not found]

|   |   |   |   |   |   |   |   |   |   |   |   |   |   |   |   |
|---|---|---|---|---|---|---|---|---|---|---|---|---|---|---|---|
| < | 1 | > | D | I | A | G | . | . | . | . | V | 1 | . | 2 | A |
| N | O | R | M | A | L | . | E | N | D | . | . | . | . | . | . |

(16) The results are displayed. (Normal end)

[PAUSE]

(17) Press the [PAUSE] key.

|   |   |   |   |   |   |   |   |   |   |   |   |   |   |   |   |
|---|---|---|---|---|---|---|---|---|---|---|---|---|---|---|---|
| < | 1 | > | D | I | A | G | . | . | . | . | V | 1 | . | 2 | A |
| . | . | . | . | . | . | . | . | . | . | . | . | . | . | . | . |

(18) The self-test menu is displayed.

[When a broken dot error is found]

|   |   |   |   |   |   |   |   |   |   |   |   |   |   |   |   |
|---|---|---|---|---|---|---|---|---|---|---|---|---|---|---|---|
| < | 1 | > | D | I | A | G | . | . | . | . | V | 1 | . | 2 | A |
| H | E | A | D | . | E | R | R | O | R | . | . | . | . | . | . |

(16') The results are displayed. (Error end)

[PAUSE]

(17') Press the [PAUSE] key.

|   |   |   |   |   |   |   |   |   |   |   |   |   |   |   |   |
|---|---|---|---|---|---|---|---|---|---|---|---|---|---|---|---|
| < | 1 | > | D | I | A | G | . | . | . | . | V | 1 | . | 2 | A |
| . | . | . | . | . | . | . | . | . | . | . | . | . | . | . | . |

(18') The self-test menu is displayed.

## 6.2.2 Self-test Items

### (1) Printing of maintenance counter values and various parameter values

#### ① Maintenance counter values

- Total label distance covered (cannot be cleared)
- Label distance covered
- Print distance
- Cut count
- Ribbon motor drive time
- RS-232C hardware error count
- System error count
- Momentary power interruption count

#### ② Various parameter values

[Value programmed on the PC]

- Feed amount fine adjustment value
- Cut (strip) position fine adjustment value
- Reverse feed amount fine adjustment value
- Print tone fine adjustment value (Thermal transfer print mode)
- Print tone fine adjustment value (Direct thermal print mode)
- Ribbon motor drive voltage fine adjustment (Take-up)
- Ribbon motor drive voltage fine adjustment (Feed)

[Value programmed using the keys]

- Feed amount fine adjustment value
- Cut (strip) position fine adjustment value
- Reverse feed amount fine adjustment value
- Print tone fine adjustment value (Thermal transfer print mode)
- Print tone fine adjustment value (Direct thermal print mode)
- Ribbon motor drive voltage fine adjustment (Take-up)
- Ribbon motor drive voltage fine adjustment (Feed)
- X-coordinate fine adjustment value
- Reflective sensor manual threshold fine adjustment
- Transmissive sensor manual threshold fine adjustment
- Character code
- Font "0"
- RS232C communication speed
- RS232C data length
- RS232C stop bit length
- RS232C parity
- RS232C flow control method
- Language for LCD messages
- Forward feed standby after an issue
- Control code type
- Strip wait status
- [FEED] key function
- Kanji code
- Euro code
- Automatic head broken dots check
- Centronics ACK/BUSY timing
- Web printer function
- Reset process when the nInit signal is ON
- Ribbon near end detection
- Expansion I/O operation mode
- Plug-and-play operation
- Label end/ribbon error process
- Pre-strip process (When this parameter is set to ON, a feed amount becomes fine adjustable.)
- Reverse feed speed
- MaxiCode specification



- Keyboard I/F
- Automatic calibration
- LAN enable/disable
- IP address
- MAC address
- BASIC
- Socket communication port number
- BASIC interpreter
- DHCP
- RFID module type
- RFID tag type
- RFID error tag detection
- Maximum number of issue retries
- Maximum number of read retries
- Read retry time-out
- Maximum number of write retries
- Write retry time-out
- RFID adjustment for retry
- Radio output power level
- AGC threshold
- RFID channel
- Number of times tag data write succeeded
- Number of times tag data write failed
- Q value
- AGC threshold for data write
- AGC threshold lower limit for retry
- Strip motor torque
- RTC low battery check
- RTC data renewal timing
- Print head applied current table setting

(2) Automatic self-test

- ① Memory check
  - Program area (Model, creation date, version, part number, checksum)
  - Boot area (Model, creation date, version, checksum)
  - HTML area (Model, creation date, version, checksum)
  - Font area checksum
  - Bit map Kanji ROM checksum (Gothic, Mincho, Chinese Kanji)
  - EEPROM check
  - RAM check
- ② Sensor check
  - Strip sensor
  - Thermal head open sensor
  - Front cover open sensor
  - Cutter home position sensor
  - Ribbon take-up motor sensor
  - Ribbon feed motor sensor
  - Thermal head thermistor
  - Ambient temperature sensor
  - Reflective sensor
  - Transmissive sensor
  - No paper level
  - Manual threshold level
- ③ Thermal head check
  - Thermal head resistance rank
  - Resolution
- ④ Expansion I/O loop back check

- ⑤ Internal serial interface loop back check
- ⑥ SIO loop back check
- ⑦ Strip sensor check
- ⑧ RFID module check

Print Samples of Self-test Result

(1) Maintenance counter values and various parameter values

|                 |        |                         |        |
|-----------------|--------|-------------------------|--------|
| TOTAL FEED      | 1.1km  |                         | [QM]   |
| FEED            | 1.1km  |                         |        |
| PRINT           | 0.5km  |                         |        |
| CUT             | 96     |                         |        |
| RIBBON          | 3h     |                         |        |
| 232C ERR        | 255    |                         |        |
| SYSTEM ERR      | 0      |                         |        |
| POWER FAIL      | 0      |                         |        |
| [PC]            |        | [KEY]                   |        |
| FEED            | +2.0mm | FEED                    | +0.0mm |
| CUT             | +0.0mm | CUT                     | +1.0mm |
| BACK            | +0.0mm | BACK                    | +0.0mm |
| TONE(T)         | +0step | TONE(T)                 | +0step |
| TONE(D)         | +0step | TONE(D)                 | +0step |
| RBN(FW)         | -10    | RBN(FW)                 | -8     |
| RBN(BK)         | +0     | RBN(BK)                 | +0     |
| X ADJ.          | +0.0mm |                         |        |
| THRESHOLD(R)    | 1.0V   |                         |        |
| THRESHOLD(T)    | 1.4V   |                         |        |
| FONT            |        | [PC-850]                | [0]    |
| SPEED           |        | [9600]                  |        |
| DATA LENG.      |        | [8]                     |        |
| STOP BIT        |        | [1]                     |        |
| PARITY          |        | [EVEN]                  |        |
| CONTROL         |        | [XON+READY AUTO]        |        |
| MESSAGE         |        | [ENGLISH]               |        |
| FORWARD WAIT    |        | [ON] +0.0mm             |        |
| CODE            |        | [AUTO]                  |        |
| PEEL OFF STATUS |        | [ON]                    |        |
| FEED KEY        |        | [FEED]                  |        |
| KANJI           |        | [TYPE1]                 |        |
| EURO CODE       |        | [B0]                    |        |
| AUTO HD CHK     |        | [OFF]                   |        |
| ACK/BUSY        |        | [TYPE1]                 |        |
| WEB PRINTER     |        | [OFF]                   |        |
| INPUT PRIME     |        | [ON]                    |        |
| RIBBON NEAR END |        | [OFF]                   |        |
| EX.I/O MODE     |        | [TYPE1]                 |        |
| PLUG & PLAY     |        | [OFF]                   |        |
| LBL/RBN END     |        | [TYPE1]                 |        |
| PRE PEEL OFF    |        | [ON] +0.0mm             |        |
| BACK SPEED      |        | [STD]                   |        |
| MAXI CODE SPEC. |        | [TYPE1]                 |        |
| KB I/F          |        | [OFF]                   |        |
| AUTO CALIB.     |        | [OFF]                   |        |
| LAN             |        | [ON]                    |        |
| PRTR IP ADDRESS |        | [192.168.010.020]       |        |
| GATE IP ADDRESS |        | [000.000.000.000]       |        |
| SUBNET MASK     |        | [255.255.255.000]       |        |
| MAC ADDRESS     |        | [00-80-91-34-00-CC]     |        |
| TTF AREA        |        | [1280KB]                |        |
| EXT CHR AREA    |        | [ 256KB]                |        |
| BASIC AREA      |        | [ 128KB]                |        |
| PC SAVE AREA    |        | [ 128KB]                |        |
| SOCKET PORT     |        | [OFF] [08000]           |        |
| BASIC           |        | [OFF]                   |        |
| BASIC TRACE     |        | [OFF]                   |        |
| DHCP            |        | [OFF]                   |        |
| DHCP ID         |        | [FFFFFFFFFFFFFFFFFFFFF] |        |
|                 |        | [FFFFFFFFFFFFFFF]       |        |
| DHCP HOST NAME  |        | [ABCDEFGHIJKLMN0P]      |        |

|                      |                         |
|----------------------|-------------------------|
| RFID MODULE          | [U2]                    |
| RFID TAG TYPE        | [NONE ]                 |
| RFID ERR CHECK       | [OFF]                   |
| RFID RETRY           | [ 3]                    |
| RFID RD CYCLE        | [ 5] [4.0sec]           |
| RFID WT CYCLE        | [ 5] [2.0sec]           |
| RFID ADJ RETRY       | [+00mm]                 |
| RFID POWER LEV       | [ 18]                   |
| RFID AGC THR.        | [0]                     |
| RFID CHANNEL         | [AUTO] <sup>NOTE2</sup> |
| RFID Q VAL           | [2]                     |
| RFID WT AGC          | [11]                    |
| RFID WT AGC MIN      | [11]                    |
| RFID WT OK TAGS      | 0                       |
| RFID VOID PRINT TAGS | 0                       |
| PEEL OFF TRQ         | [R0]                    |
| RTC BATT. CHK        | [ON]                    |
| RTC RENEWAL          | [PAGE]                  |
| TONE TABLE           | [TYPE1]                 |

**NOTES:**

1. Print conditions:

Label length of 306 mm, thermal transfer/direct thermal print mode<sup>(\*)</sup>, no sensors used, 4 ips, one-label issue, batch issue  
 (\*1) Depends on the print type setting.

2. RFID channel setting menu is not available to the B-SA704-RFID-U2-EU-R.

(2) Automatic self-test

|         |                   |             |
|---------|-------------------|-------------|
| PROGRAM | B-SA4T            | 7FM01051000 |
| MAIN    | 15OCT2005         | V1.0A:1A00  |
| BOOT    | 20SEP2005         | V1.0 :8500  |
| HTML    | 19MAR2007         | V1.0A:6700  |
|         |                   |             |
| FONT    | AD00              |             |
| KANJI   | GOTHIC :9F00      |             |
|         | MINCHO:7400       |             |
| EEPROM  | OK                |             |
| SDRAM   | 8MB               |             |
| SENSOR1 | 00000000,00000111 |             |
| SENSOR2 | [H]23°C [A]22°C   |             |
|         | [R]4.2V [T]2.5V   |             |
| PE LV.  | [R]1.2V [T]4.3V   |             |
| M THRE. | [R]5.0V [T]5.0V   |             |
|         | [RANK]1 203DPI    |             |
| EXP.I/O | NG                |             |
| EX.232C | NG                |             |
| SIO     | NG NG             |             |
| STRIP   | NG                |             |
| RFID    | OK #00QV972       |             |

**NOTES:** 1. *Print conditions: Label length of 122mm, thermal transfer/direct thermal print mode<sup>(\*1)</sup>, no sensors used, 4 ips, one-label issue, batch issue*

*(\*1) Depends on the ribbon setting.*

2. *“°” used for “°C” may not be printed correctly, depending on the type of the character code selected.*

### 6.2.2.1 Details of Self-test Result

(1) Maintenance counter values

| Item                    | Description   | Range            |
|-------------------------|---|------------------|
| TOTAL FEED              | Total label distance covered<br>(cannot be cleared) | 0.0 to 3200.0 km |
| FEED                    | Label distance covered                              | 0.0 to 3200.0 km |
| PRINT                   | Print distance                                      | 0.0 to 200.0 km  |
| CUT                     | Cut count   | 0 to 1000000     |
| RIBBON                  | Ribbon motor drive time                             | 0 to 2000 hours  |
| 232C ERR                | RS-232C hardware error count                        | 0 to 255         |
| SYSTEM ERR              | System error count                                  | 0 to 15          |
| POWER FAIL              | Momentary power interruption count                  | 0 to 15          |
| RFID WT OK<br>TAGS      | The number of times a tag data write<br>succeeded   | 0 to 9999999     |
| RFID VOID<br>PRINT TAGS | The number of times a tag data write failed         | 0 to 9999999     |

| Maintenance Counter                                    | Count Conditions  |
|--|---|
| Total label distance covered<br>Label distance covered | Counts whenever the paper feed motor is driven to feed or print a label. (Counts also during a reverse feed operation.)<br>When the power is turned off, a label distance of up to 50.0 cm may be rounded down and backed up.   |
| Print distance   | Counts while printing. (Counting is not performed during a backfeed operation.)<br>203 dpi:<br>When the power is turned off, a print distance of 8.2 m or less is rounded down and backed up.<br>300 dpi:<br>When the power is turned off, a print distance of 5.5 m or less is rounded down and backed up.                               |
| Cut count  | Every cut operation is counted.<br>When the power is turned off, a cut count of 31 or less is rounded down and backed up.   |
| Ribbon motor drive time                                | Counts when the ribbon motor is driven to feed or print a label. (Counts also during a backfeed operation.)<br>203 dpi:<br>When the power is turned off, a drive time of 32 seconds or less is rounded down and backed up.<br>300 dpi:<br>When the power is turned off, a drive time of 27 seconds or less is rounded down and backed up. |
| RS-232C hardware error count                           | Counts when a parity error, an overrun error, or a framing error occurs.<br>* When data of several bytes is transmitted continuously, counting is performed per byte.   |
| System error count                                     | Counts when a system error of No. 22 listed in section 5.11 "LCD MESSAGES AND LED INDICATIONS" occurs.  |

| Maintenance Counter                             | Count Conditions                                       |
|---|--|
| Momentary power interruption count              | Counts when a momentary power interruption occurs.     |
| The number of times a tag data write succeeded. | Counts the number of times a tag data write succeeded. |
| The number of times a tag data write failed.    | Counts the number of times a tag data write failed.    |

(2) Various parameters values

| Item                      | Description  | Specification                            |
|---------------------------|--|--|
| <b>[PC] FEED</b>          | Feed amount fine adjustment                              | -50.0 mm to +50.0 mm (See <b>NOTE.</b> ) |
| <b>CUT</b>                | Cut (strip) position fine adjustment                     | -50.0 mm to +50.0 mm (See <b>NOTE.</b> ) |
| <b>BACK</b>               | Reverse feed amount fine adjustment                      | -9.9 mm to +9.9 mm (See <b>NOTE.</b> )   |
| <b>TONE(T)</b>            | Print tone fine adjustment (Thermal transfer print mode) | -10 to +10 step                          |
| <b>TONE(D)</b>            | Print tone fine adjustment (Direct thermal print mode)   | -10 to +10 step                          |
| <b>RBN(FW)</b>            | Ribbon motor drive voltage fine adjustment (Take-up)     | -15 to +0 step                           |
| <b>RBN(BK)</b>            | Ribbon motor drive voltage fine adjustment (Feed)        | -15 to +0 step                           |
| <b>[KEY] FEED</b>         | Feed amount fine adjustment                              | -50.0 mm to +50.0 mm                     |
| <b>CUT</b>                | Cut (strip) position fine adjustment                     | -50.0 mm to +50.0 mm                     |
| <b>BACK</b>               | Reverse feed amount fine adjustment                      | -9.9 mm to +9.9 mm                       |
| <b>TONE(T)</b>            | Print tone fine adjustment (Thermal transfer print mode) | -10 to +10 step                          |
| <b>TONE(D)</b>            | Print tone fine adjustment (Direct thermal print mode)   | -10 to +10 step                          |
| <b>RBN(FW)</b>            | Ribbon motor drive voltage fine adjustment (Take-up)     | -15 to +2 step                           |
| <b>RBN(BK)</b>            | Ribbon motor drive voltage fine adjustment (Feed)        | -15 to +10 step                          |
| <b>X ADJ.</b>             | X-coordinate fine adjustment                             | -99.9 mm to +99.9 mm                     |
| <b>THRESHOLD&lt;R&gt;</b> | Reflective sensor manual threshold fine adjustment       | 0.0 V to 4.0 V                           |
| <b>THRESHOLD&lt;T&gt;</b> | Transmissive sensor manual threshold fine adjustment     | 0.0 V to 4.0 V                           |

| Item              | Description                | Specification  |
|-------------------|----------------------------|--|
| <b>FONT</b>       | Character code             | PC-850: PC-850<br>PC-852: PC-852<br>PC-857: PC-857<br>PC-8: PC-8<br>PC-851: PC-851<br>PC-855: PC-855<br>PC-866: PC-866<br>PC-1250: PC-1250<br>PC-1251: PC-1251<br>PC-1252: PC-1252<br>PC-1253: PC-1253<br>PC-1254: PC-1254<br>PC-1257: PC-1257<br>LATIN9: LATIN9<br>Arabic: Arabic<br>UTF-8: UTF-8   |
|                   | Font "0"                   | 0 : Without slash<br>Ø : With slash  |
| <b>SPEED</b>      | RS232C communication speed | 2400: 2400 bps<br>4800: 4800 bps<br>9600: 9600 bps<br>19200: 19200 bps<br>38400: 38400 bps<br>115200: 115200 bps   |
| <b>DATA LENG.</b> | RS232C data length         | 7: 7 bits<br>8: 8 bits   |
| <b>STOP BIT</b>   | RS232C stop bit length     | 1: 1 bit<br>2: 2 bits  |
| <b>PARITY</b>     | RS232C parity              | NONE: None parity<br>ODD: ODD parity<br>EVEN: EVEN parity  |
| <b>CONTROL</b>    | RS232C flow control method | XON/XOFF: XON/XOFF protocol<br>(No XON output when the power is on, no XOFF output when the power is off)<br>READY/BUSY: READY/BUSY (DTR) protocol<br>(No XON output when the power is on, no XOFF output when the power is off)<br>XON+READY AUTO:<br>XON/XOFF + READY/BUSY (DTR) protocol<br>(XON output when the power is on, XOFF output when the power is off)<br>XON/XOFF AUTO:<br>XON/XOFF protocol<br>(XON output when the power is on, XOFF output when the power is off)<br>READY/BUSY RTS: RTS protocol<br>(No XON output when the power is on, no XOFF output when the power is off) |

| Item                | Description                               | Specification  |
|---------------------|---|--|
| <b>MESSAGE</b>      | Language for LCD messages                 | ENGLISH: English<br>GERMAN: German<br>FRENCH: French<br>DUTCH: Dutch<br>SPANISH: Spanish<br>JAPANESE: Japanese<br>ITALIAN: Italian   |
| <b>FORWARD WAIT</b> | Forward feed standby after an issue       | ON: Enabled<br>(A fine adjustment value for the stop position is also printed.)<br>OFF: Disabled   |
| <b>CODE</b>         | Control code                              | AUTO: Automatic selection<br>ESC LF NUL: ESC LF NUL method<br>{   }: {   } method<br>xx○○△△ Any code set (Described in hex. code)<br>IBM HOST: 「 」 method<br><i>Only for the Japan model</i> |
| <b>PEEL OFF STS</b> | Strip wait status                         | ON: Enabled<br>OFF: Disabled   |
| <b>FEED KEY</b>     | [FEED] key function                       | FEED: Feeds one label.<br>PRINT: Prints data in the image buffer on one label.   |
| <b>KANJI</b>        | Kanji code                                | TYPE1: For Windows codes<br>TYPE2: For original codes  |
| <b>EURO CODE</b>    | Euro code                                 | 20H to FFH   |
| <b>AUTO HD CHK</b>  | Automatic head broken dots check          | ON: A head broken dots check is automatically performed when the power is turned on.<br>OFF: A head broken dots check is not automatically performed when the power is turned on.            |
| <b>ACK/BUSY</b>     | Centronics ACK/BUSY timing                | TYPE 1: BUSY goes low at the same time as when ACK goes high.<br>TYPE 2: BUSY goes low at the same time as when ACK goes low.  |
| <b>WEB PRINTER</b>  | Web printer function                      | ON: Web printer function is enabled.<br>OFF: Web printer function is disabled.   |
| <b>INPUT PRIME</b>  | Reset process when the nlnit signal is ON | ON: The reset process is performed.<br>OFF: The reset process is not performed.  |

| Item                   | Description                          | Specification   |
|------------------------|--------------------------------------|---|
| <b>RIBBON NEAR END</b> | Ribbon near end detection            | 30 m: A ribbon near end state is detected when the remaining ribbon length is approximately 30 m.<br>70 m: A ribbon near end state is detected when the remaining ribbon length is approximately 70 m.<br>OFF: A ribbon near end state is not detected. |
| <b>EX.I/O MODE</b>     | Expansion I/O operation mode         | TYPE1: Standard mode<br>TYPE2: In-line mode   |
| <b>PLUG &amp; PLAY</b> | Plug-and-play operation              | ON: A plug-and-play operation is performed.<br>OFF: A plug-and-play operation is not performed.   |
| <b>LBL/RBN END</b>     | Label end/ribbon error process       | TYPE1: When a label end or ribbon error state is detected, the printer stops even if it is printing.<br>TYPE2: When a label end or ribbon error state is detected, the printer prints the current label as far as possible, then stops.                 |
| <b>PRE PEEL OFF</b>    | Pre-strip process                    | ON: A pre-strip operation is performed.<br>(When ON is selected, a feed amount is fine adjustable.)<br>OFF: A pre-strip operation is not performed.   |
| <b>BACK SPEED</b>      | Reverse feed speed                   | STD: 3 ips<br>LOW: 2 ips  |
| <b>MAXI CODE SPEC.</b> | MaxiCode specification               | TYPE1: Compatible with a current version<br>TYPE2: Special specification  |
| <b>KB I/F</b>          | Keyboard I/F                         | OFF: Disabled<br>KB60(1): KB-60 Old version<br>KB60(2): KB-60 Current version<br>KB80: KB-80  |
| <b>AUTO CALIB.</b>     | Automatic calibration                | OFF Disabled<br>ON TRANS: Enabled with the transmissive sensor<br>ON REFLECT: Enabled with the reflective sensor  |
| <b>LAN</b>             | Enabling or disabling the LAN        | ON: Enabled<br>OFF: Disabled  |
| <b>PRTR IP ADDRESS</b> | Printer IP address                   | *** **  |
| <b>GATE IP ADDRESS</b> | Gateway IP address                   | *** **  |
| <b>SUBNET MASK</b>     | Subnet mask                          | *** **  |
| <b>MAC ADDRESS</b>     | MAC address                          | **_*_*_*_*_*_*_*  |
| <b>TTF AREA</b>        | TrueType font storage area size      | 0 KB to 3072 KB (in units of 128 KB)  |
| <b>EXT CHR AREA</b>    | Writable character storage area size | 0 KB to 3072 KB (in units of 128 KB)  |
| <b>BASIC AREA</b>      | BASIC file storage area size         | 00 KB to 3072 KB (in units of 128 KB)   |
| <b>PC SAVE AREA</b>    | PC saving area size                  | 0 KB to 3072 KB (in units of 128 KB)  |



| Item                    | Description   | Specification   |
|-------------------------|---|---|
| <b>SOCKET PORT</b>      | Socket communication port number                        | ON: Socket communication function is enabled.<br>OFF: Socket communication function is disabled.<br>Port number: 0 to 65535 |
| <b>BASIC</b>            | BASIC interpreter                                       | ON: BASIC interpreter function is enabled.<br>OFF: BASIC interpreter function is disabled.                                  |
| <b>BASIC TRACE</b>      | BASIC interpreter trace                                 | ON: Trace function is enabled.<br>OFF: Trace function is disabled.  |
| <b>DHCP</b>             | DHCP  | ON: DHCP function is enabled.<br>OFF: DHCP function is disabled.  |
| <b>DHCP ID</b>          | DHCP ID   | Max. 16 characters  |
| <b>DHCP HOST NAME</b>   | DHCP HOST NAME  | Max. 16 characters  |
| <b>RFID MODULE</b>      | RFID module type  | NONE: No RFID kit is installed.<br>U2: B-SA704-RFID-U2  |
| <b>RTID TAG TYPE</b>    | RFID tag type   | NONE<br>EPC C1 Gen2: 24   |
| <b>RFID ERR CHECK</b>   | Error tag detection                                     | ON: An error tag detection is performed.<br>OFF: An error tag detection is not performed.                                   |
| <b>RFID RETRY</b>       | Maximum number of issue retries                         | 0 to 255  |
| <b>RFID RD CYCLE</b>    | Maximum number of read retries<br>Read retry time-out   | 0 to 255<br>0 sec. to 9.9 sec.  |
| <b>RFID WT CYCLE</b>    | Maximum number of write retries<br>Write retry time-out | 0 to 255<br>0 sec. to 9.9 sec.  |
| <b>RFID ADJ RETRY</b>   | RFID adjustment for retry                               | -99 mm to +99mm   |
| <b>RFID POWER LEVEL</b> | Radio output power level                                | 9 to 18   |
| <b>RFID THRESHOLD</b>   | AGC threshold   | 0 to 15   |
| <b>RFID RF CHANNEL</b>  | RFID channel  | 2CH to 8CH<br>AUTO<br><b>Note:</b> This menu is not available to the B-SA704-RFID-U2-EU-R.                                  |
| <b>RFID Q VAL</b>       | Q value   | 0 to 5  |
| <b>RFID WT AGC</b>      | AGC threshold for data write                            | 0 to 15   |
| <b>RFID WT MIN AGC</b>  | AGC threshold lower limit for retry                     | 0 to 15   |
| <b>PEEL OFF TRQ</b>     | Strip motor torque                                      | R0: Low<br>R1: ↑<br>R2: ↓<br>R3: High   |
| <b>RTC BATT.CHK</b>     | RTC low battery check                                   | ON: Enabled<br>OFF: Disabled  |
| <b>RTC RENEWAL</b>      | RTC data renewal timing                                 | BATCH: Per batch<br>PAGE: Per page  |
| <b>TONE TABLE</b>       | Print head applied current table setting                | TYPE1: Standard table<br>TYPE2: Additional table 1  |

**NOTE:** For 203 dpi, the head density is 8 dots/mm. The operation to be performed is the same for both cases: when the value is set to "x.2 mm" and when the value is set to "x.3 mm". Therefore, "x.3 mm" is printed in the self-test result, even if "x.2 mm" is set. Similarly, if "x.7 mm" is set, "x.8 mm" is printed in the self-test result.

(3) Memory check

PROGRAM B-SA4T 7FM00226000  
MAIN 15OCT2002 V1.0A:1A00

Model name  
Part number  
Checksum  
Version  
Creation date (Day-Month-Year)  
Name PROGRAM: Program area

BOOT 20SEP2002 V1.0 :8500

Checksum  
Version  
Creation date (Day-Month-Year)  
Name BOOT: Boot area

FONT 5600

Checksum of font area

KANJI NONE :0000 — Checksum of bit map Kanji ROM for Gothic font  
NONE: No Kanji ROMs installed  
GOTHIC: Bit map Kanji ROM for Gothic font installed

NONE :0000 — Checksum of bit map Kanji ROM for Mincho font (or Chinese Kanji)  
NONE: No Kanji ROMs installed  
MINCHO: Bit map Kanji ROM for Mincho font installed  
CHINESE: Bit map Kanji ROM for Chinese Kanji installed

EEPROM OK

OK: Data in the check area can be properly read/written.  
NG: Data in the check area cannot be properly read/rewritten.  
Backup memory (EEPROM)

SDRAM 8MB

Capacity of SDRAM  
Memory for the system and drawing

(4) Sensor check

**SENSOR1 00000000,00000000**

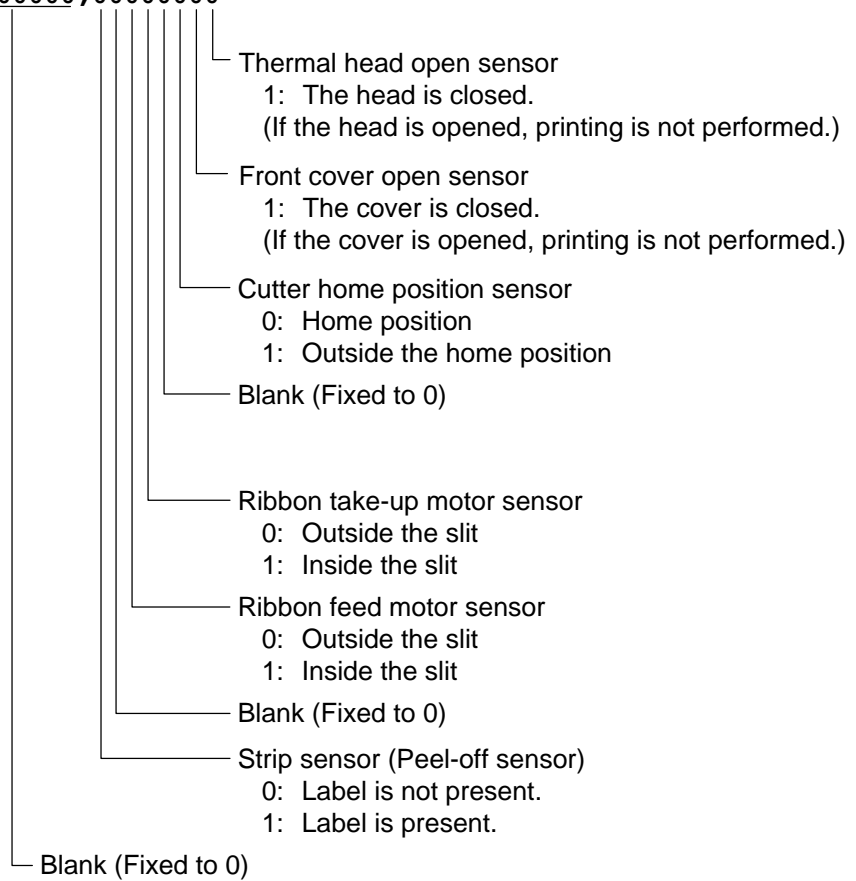

**SENSOR2 [H]20°C [A]22°C**

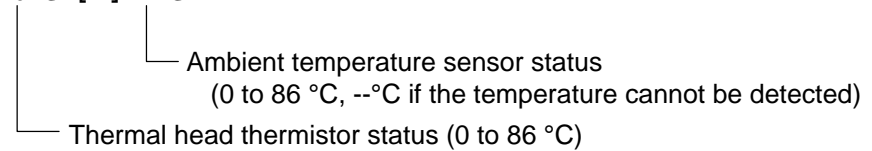

**[R]4.2V [T]2.5V**

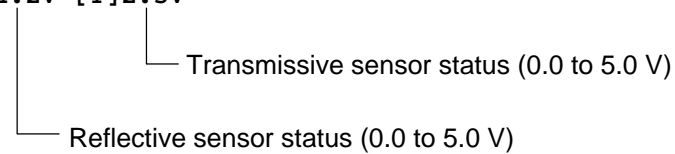

**PE LV. [R]1.2V [T]4.3V**

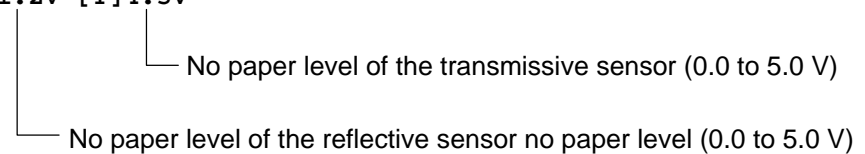

**M THRE. [R]5.0V [T]5.0V**

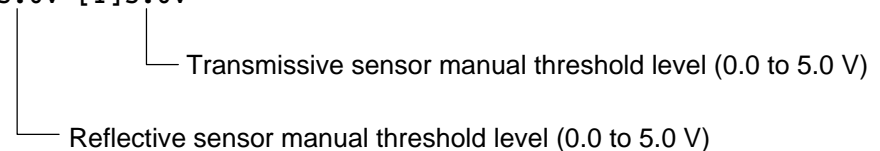

[RANK]1 203DPI  
 Resolution of head installed  
 Thermal head resistance rank

| Resistance rank | 203 dpi                  | 300 dpi      |
|-----------------|--------------------------|--------------|
|                 | Average resistance (ohm) |              |
| 0               | 748 to 758               | 1100 to 1116 |
| 1               | 759 to 770               | 1117 to 1133 |

(5) Expansion I/O check

**EXP. I/O NG**  
 OK: Normal data  
 NG: Abnormal data, or the loop-back jig is not connected.  
 Expansion I/O

\* Connect the cable as illustrated below, then check the following cases: high output/high input, low output/low input.

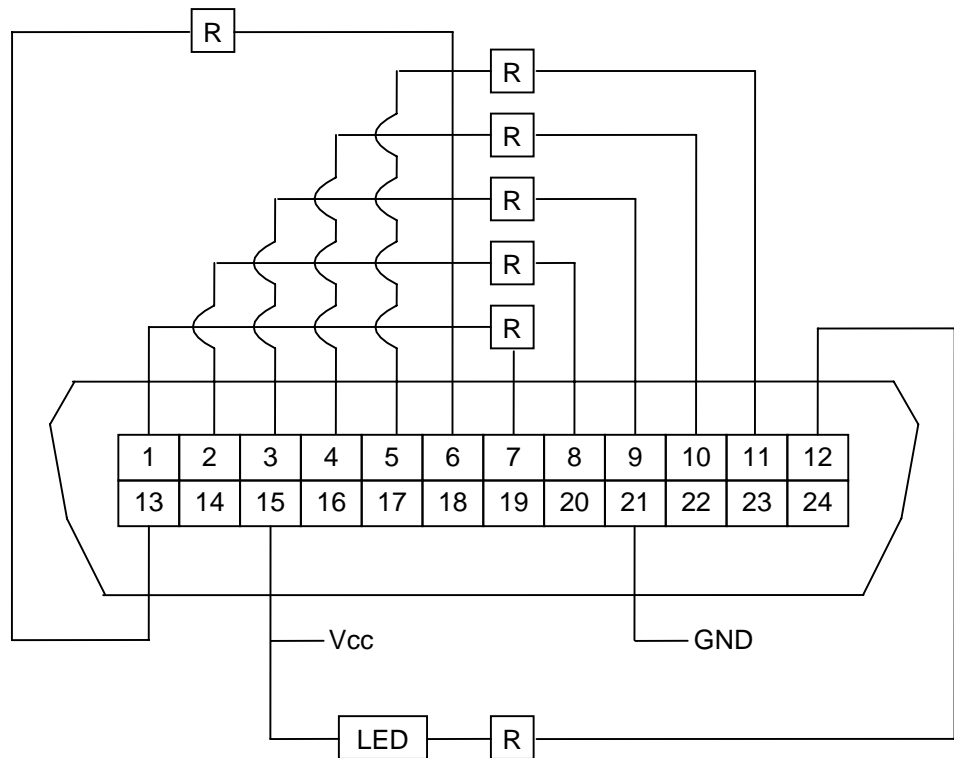

R = 300 ohms  
 Connector: FCN-781P024-G/P

(6) Internal serial I/F check

**EX. 232C NG**  
 OK: Normal data  
 NG: Abnormal data, or the loop-back jig is not connected.  
 Internal serial I/F

(7) SIO I/F check

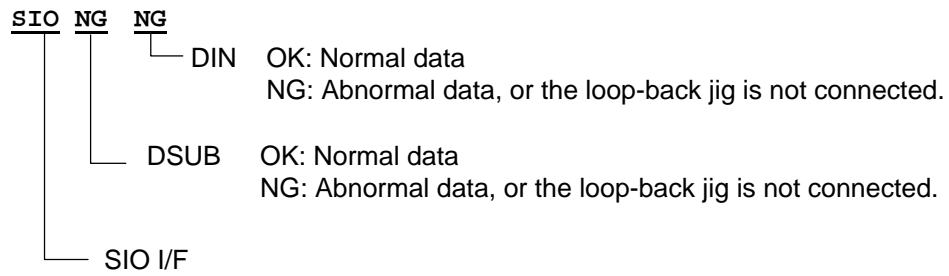

(8) Strip sensor check

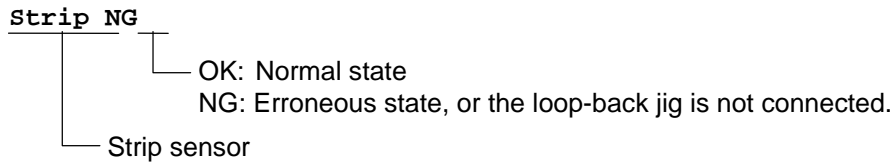

(9) RFID module check

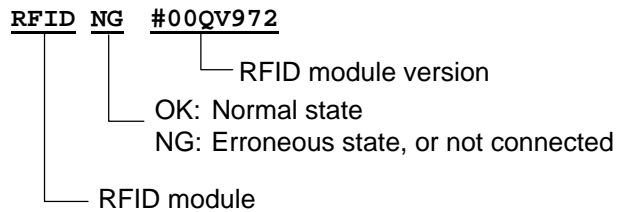

## 6.3 VARIOUS PARAMETERS SETTING

### 6.3.1 Various Parameters Setting Operation Example

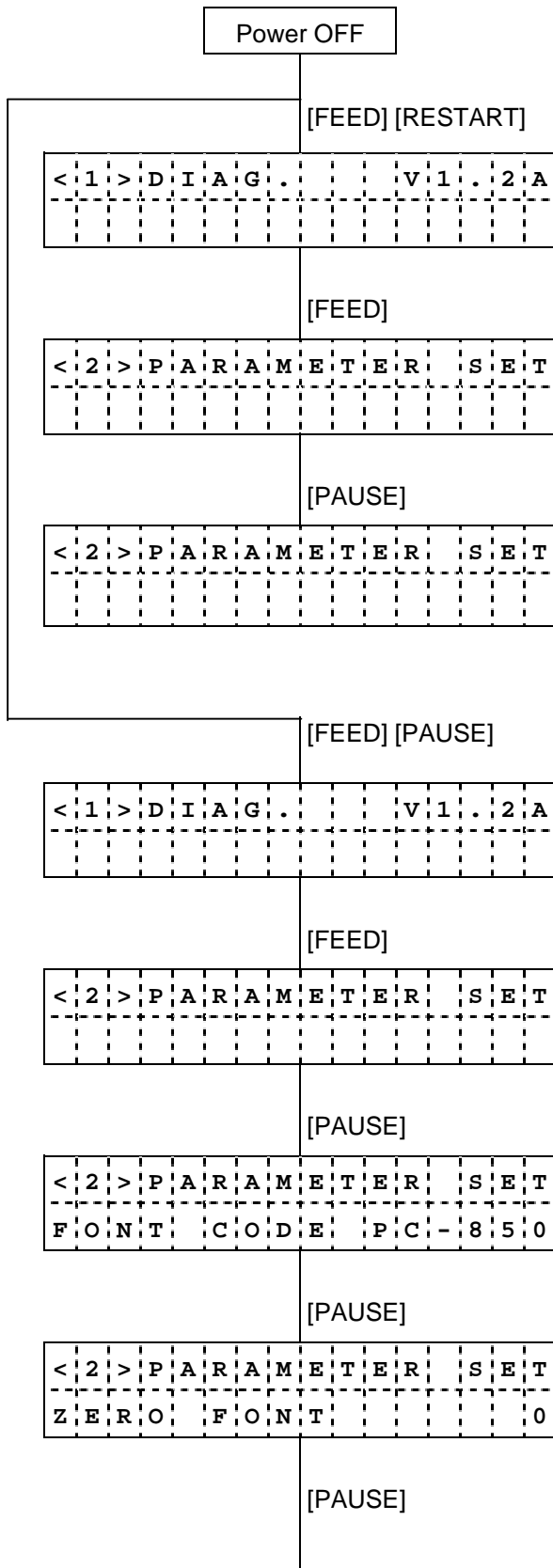

- (1) Power off state
- (2) While holding the [FEED] and [RESTART] keys down, turn the power on.
- (3) The self-test menu is displayed.
- (4) Press the [FEED] key.
- (5) System mode menu display (Parameter setting)
- (6) Press the [PAUSE] key.
- (7) System mode menu display (Parameter setting)
- (2) While holding the [FEED] and [PAUSE] keys down, turn the power on.
- (3) The self-test menu is displayed.
- (4) Press the [FEED] key.
- (5) System mode menu display (Parameter setting)
- (6) Press the [PAUSE] key.
- (7) Font code setting:  
Select a font code using the [FEED] and [RESTART] keys.
- (8) Press the [PAUSE] key.
- (9) Font "0" setting:  
Select a style of zero (0) using the [FEED] and [RESTART] keys.
- (10) Press the [PAUSE] key.

|   |   |   |   |   |   |   |   |   |   |   |   |   |   |   |   |   |   |   |
|---|---|---|---|---|---|---|---|---|---|---|---|---|---|---|---|---|---|---|
| < | 2 | > | P | A | R | A | M | E | T | E | R | S | E | T |   |   |   |   |
| S | P | E | E | D |   |   |   |   |   |   |   | 9 | 6 | 0 | 0 | b | p | s |

[PAUSE]

|   |   |   |   |   |   |   |   |   |   |   |   |   |   |   |   |   |
|---|---|---|---|---|---|---|---|---|---|---|---|---|---|---|---|---|
| < | 2 | > | P | A | R | A | M | E | T | E | R | S | E | T |   |   |
| D | A | T | A | L | E | N | G | . |   |   |   | 8 | b | i | t | s |

[PAUSE]

|   |   |   |   |   |   |   |   |   |   |   |   |   |   |   |   |
|---|---|---|---|---|---|---|---|---|---|---|---|---|---|---|---|
| < | 2 | > | P | A | R | A | M | E | T | E | R | S | E | T |   |
| S | T | O | P | B | I | T |   |   |   |   |   | 1 | b | i | t |

[PAUSE]

|   |   |   |   |   |   |   |   |   |   |   |   |   |   |   |   |
|---|---|---|---|---|---|---|---|---|---|---|---|---|---|---|---|
| < | 2 | > | P | A | R | A | M | E | T | E | R | S | E | T |   |
| P | A | R | I | T | Y |   |   |   |   |   |   | E | V | E | N |

[PAUSE]

|   |   |   |   |   |   |   |   |   |   |   |   |   |   |   |   |
|---|---|---|---|---|---|---|---|---|---|---|---|---|---|---|---|
| < | 2 | > | P | A | R | A | M | E | T | E | R | S | E | T |   |
| X | O | N | + | R | E | A | D | Y |   |   |   | A | U | T | O |

[PAUSE]

|   |   |   |   |   |   |   |   |   |   |   |   |   |   |   |   |   |   |   |
|---|---|---|---|---|---|---|---|---|---|---|---|---|---|---|---|---|---|---|
| < | 2 | > | P | A | R | A | M | E | T | E | R | S | E | T |   |   |   |   |
| L | C | D |   |   |   |   |   |   |   |   |   | E | N | G | L | I | S | H |

[PAUSE]

|   |   |   |   |   |   |   |   |   |   |   |   |   |   |   |
|---|---|---|---|---|---|---|---|---|---|---|---|---|---|---|
| < | 2 | > | P | A | R | A | M | E | T | E | R | S | E | T |
| F | O | R | W | A | R | D | W | A | I | T | O | O | F | F |

[PAUSE]

|   |   |   |   |   |   |   |   |   |   |   |   |   |   |   |
|---|---|---|---|---|---|---|---|---|---|---|---|---|---|---|
| < | 2 | > | P | A | R | A | M | E | T | E | R | S | E | T |
| C | O | D | E |   | E | S | C | , | L | F | , | N | U | L |

[PAUSE]

|   |   |   |   |   |   |   |   |   |   |   |   |   |   |   |
|---|---|---|---|---|---|---|---|---|---|---|---|---|---|---|
| < | 2 | > | P | A | R | A | M | E | T | E | R | S | E | T |
| P | E | E | L | O | F | F | S | T | S | O | F | F |   |   |

[PAUSE]

(11) RS232C communication speed setting:  
Select a communication speed using the [FEED] and [RESTART]

(12) Press the [PAUSE] key.

(13) RS232C data length setting:  
Select a data length using the [FEED] and [RESTART] keys.

(14) Press the [PAUSE] key.

(15) RS232C stop bit length setting:  
Select a stop bit length using the [FEED] and [RESTART] keys.

(16) Press the [PAUSE] key.

(17) RS232C parity setting:  
Select a parity value using the [FEED] and [RESTART] keys.

(18) Press the [PAUSE] key.

(19) RS232C flow control method setting:  
Select a flow control method using the [FEED] and [RESTART] keys.

(20) Press the [PAUSE] key.

(21) Setting of language for LCD messages:  
Select a language for LCD messages using the [FEED] and [RESTART] keys.

(22) Press the [PAUSE] key.

(23) Setting of forward feed standby after an issue:  
Enable/disable the forward feed standby function using the [FEED] and [RESTART] keys.

(24) Press the [PAUSE] key.

(25) Control code setting:  
Select a control code using the [FEED] and [RESTART] keys.

(26) Press the [PAUSE] key.

(27) Strip wait status setting:  
Enable/disable the Strip wait status function using the [FEED] and [RESTART] keys.

(28) Press the [PAUSE] key.

|   |   |   |   |   |   |   |   |   |   |   |   |   |   |   |   |
|---|---|---|---|---|---|---|---|---|---|---|---|---|---|---|---|
| < | 2 | > | P | A | R | A | M | E | T | E | R | S | E | T |   |
| F | E | E | D | K | E | Y |   |   |   |   |   | F | E | E | D |

(29) [FEED] key function setting:  
Select a function of the [FEED] key using the [FEED] and [RESTART] keys.

[PAUSE]

(30) Press the [PAUSE] key.

|   |   |   |   |   |   |   |   |   |   |   |   |   |   |   |
|---|---|---|---|---|---|---|---|---|---|---|---|---|---|---|
| < | 2 | > | P | A | R | A | M | E | T | E | R | S | E | T |
| K | A | N | J | I | C | O | D | E | T | Y | P | E | 1 |   |

(31) Kanji code setting:  
Select a Kanji code using the [FEED] and [RESTART] keys.

[PAUSE]

(32) Press the [PAUSE] key.

|   |   |   |   |   |   |   |   |   |   |   |   |   |   |   |
|---|---|---|---|---|---|---|---|---|---|---|---|---|---|---|
| < | 2 | > | P | A | R | A | M | E | T | E | R | S | E | T |
| E | U | R | O | C | O | D | E |   |   |   |   | B | 0 |   |

(33) Euro code setting:  
Select a Euro code using the [FEED] and [RESTART] keys.

[PAUSE]

(34) Press the [PAUSE] key.

|   |   |   |   |   |   |   |   |   |   |   |   |   |   |   |
|---|---|---|---|---|---|---|---|---|---|---|---|---|---|---|
| < | 2 | > | P | A | R | A | M | E | T | E | R | S | E | T |
| A | U | T | O | H | D | C | H | K | O | F | F |   |   |   |

(35) Automatic head broken dots check setting:  
Enable/disable the automatic head broken dots check using the [FEED] and [RESTART] keys.

[PAUSE]

(36) Press the [PAUSE] key.

|   |   |   |   |   |   |   |   |   |   |   |   |   |   |   |   |
|---|---|---|---|---|---|---|---|---|---|---|---|---|---|---|---|
| < | 2 | > | P | A | R | A | M | E | T | E | R | S | E | T |   |
| A | C | K | / | B | U | S | Y |   |   |   | T | Y | P | E | 1 |

(37) Centronics ACK/BUSY timing setting:  
Select an ACK/BUSY timing using the [FEED] and [RESTART] keys.

[PAUSE]

(38) Press the [PAUSE] key.

|   |   |   |   |   |   |   |   |   |   |   |   |   |   |   |
|---|---|---|---|---|---|---|---|---|---|---|---|---|---|---|
| < | 2 | > | P | A | R | A | M | E | T | E | R | S | E | T |
| W | E | B | P | R | I | N | T | E | R |   | O | F | F |   |

(39) Web printer function setting:  
Enable/disable the web printer function using the [FEED] and [RESTART] keys.

[PAUSE]

(40) Press the [PAUSE] key.

|   |   |   |   |   |   |   |   |   |   |   |   |   |   |   |
|---|---|---|---|---|---|---|---|---|---|---|---|---|---|---|
| < | 2 | > | P | A | R | A | M | E | T | E | R | S | E | T |
| I | N | P | U | T | P | R | I | M | E |   |   | O | N |   |

(41) Setting of reset process when the nInIt signal is ON:  
Enable/disable the reset process function using the [FEED] and [RESTART] keys.

[PAUSE]

(42) Press the [PAUSE] key.

|   |   |   |   |   |   |   |   |   |   |   |   |   |   |   |
|---|---|---|---|---|---|---|---|---|---|---|---|---|---|---|
| < | 2 | > | P | A | R | A | M | E | T | E | R | S | E | T |
| R | B | N | N | E | A | R | E | N | D |   | 7 | 0 | m |   |

(43) Ribbon near end detection setting:  
Select a remaining ribbon length to be detected as a ribbon near end state using the [FEED] and [RESTART] keys.

[PAUSE]

(44) Press the [PAUSE] key.

|   |   |   |   |   |   |   |   |   |   |   |   |   |   |   |   |
|---|---|---|---|---|---|---|---|---|---|---|---|---|---|---|---|
| < | 2 | > | P | A | R | A | M | E | T | E | R | S | E | T |   |
| E | X | . | I | / | O |   |   |   |   |   | T | Y | P | E | 1 |

(45) Expansion I/O operation mode setting:  
Select an operation mode using the [FEED] and [RESTART] keys.

[PAUSE]

(46) Press the [PAUSE] key.



|   |   |   |   |   |   |   |   |   |   |   |   |   |   |   |
|---|---|---|---|---|---|---|---|---|---|---|---|---|---|---|
| < | 2 | > | P | A | R | A | M | E | T | E | R | S | E | T |
| P | L | U | G | & | P | L | A | Y | O | F | F |   |   |   |

(47) Plug-and-play operation setting:  
Enable/disable the plug-and-play operation function using the [FEED] and [RESTART] keys.

[PAUSE]

(48) Press the [PAUSE] key.

|   |   |   |   |   |   |   |   |   |   |   |   |   |   |   |
|---|---|---|---|---|---|---|---|---|---|---|---|---|---|---|
| < | 2 | > | P | A | R | A | M | E | T | E | R | S | E | T |
| L | B | L | / | R | B | N | E | N | D | T | Y | P | E | 1 |

(49) Label end/ribbon error process setting:  
Select a label end or ribbon error process using the [FEED] and [RESTART] keys.

[PAUSE]

(50) Press the [PAUSE] key.

|   |   |   |   |   |   |   |   |   |   |   |   |   |   |   |
|---|---|---|---|---|---|---|---|---|---|---|---|---|---|---|
| < | 2 | > | P | A | R | A | M | E | T | E | R | S | E | T |
| P | R | E | P | E | E | L | O | F | F | O | F | F |   |   |

(51) Pre-strip process setting:  
Enable/disable the pre-strip process function using the [FEED] and [RESTART] keys.

[PAUSE]

(52) Press the [PAUSE] key.

|   |   |   |   |   |   |   |   |   |   |   |   |   |   |   |
|---|---|---|---|---|---|---|---|---|---|---|---|---|---|---|
| < | 2 | > | P | A | R | A | M | E | T | E | R | S | E | T |
| B | A | C | K | S | P | E | E | D | S | T | D |   |   |   |

(53) Reverse feed speed setting:  
Select a reverse feed speed using the [FEED] and [RESTART] keys.

[PAUSE]

(54) Press the [PAUSE] key.

|   |   |   |   |   |   |   |   |   |   |   |   |   |   |   |
|---|---|---|---|---|---|---|---|---|---|---|---|---|---|---|
| < | 2 | > | P | A | R | A | M | E | T | E | R | S | E | T |
| M | A | X | I | C | O | D | E | T | Y | P | E | 1 |   |   |

(55) MaxiCode specification setting:  
Select a type of MaxiCode specification using the [FEED] and [RESTART] keys.

[PAUSE]

(56) Press the [PAUSE] key.

|   |   |   |   |   |   |   |   |   |   |   |   |   |   |   |
|---|---|---|---|---|---|---|---|---|---|---|---|---|---|---|
| < | 2 | > | P | A | R | A | M | E | T | E | R | S | E | T |
| K | B | I | / | F |   |   |   |   |   |   |   | O | F | F |

(57) Keyboard I/F setting:  
Enable/disable the keyboard I/F using the [FEED] and [RESTART] keys.

[PAUSE]

(58) Press the [PAUSE] key.

|   |   |   |   |   |   |   |   |   |   |   |   |   |   |   |
|---|---|---|---|---|---|---|---|---|---|---|---|---|---|---|
| < | 2 | > | P | A | R | A | M | E | T | E | R | S | E | T |
| P | E | E | L | O | F | F | T | R | Q |   |   | R | 0 |   |

(59) Strip motor torque setting:  
Select a strip motor torque using the [FEED] and [RESTART] keys.

[PAUSE]

(60) Press the [PAUSE] key.

|   |   |   |   |   |   |   |   |   |   |   |   |   |   |   |
|---|---|---|---|---|---|---|---|---|---|---|---|---|---|---|
| < | 2 | > | P | A | R | A | M | E | T | E | R | S | E | T |
| T | O | N | E | T | A | B | L | E | T | Y | P | E | 1 |   |

(61) Print head applied current table setting:  
Select the type of table using the [FEED] or [RESTART] key.

[PAUSE]

(62) Press the [PAUSE] key.

|   |   |   |   |   |   |   |   |   |   |   |   |   |   |   |
|---|---|---|---|---|---|---|---|---|---|---|---|---|---|---|
| < | 2 | > | P | A | R | A | M | E | T | E | R | S | E | T |
|   |   |   |   |   |   |   |   |   |   |   |   |   |   |   |

(63) The parameter setting menu is displayed.

### 6.3.2 Details of Various Parameter Setting

#### (1) Character code (FONT CODE)

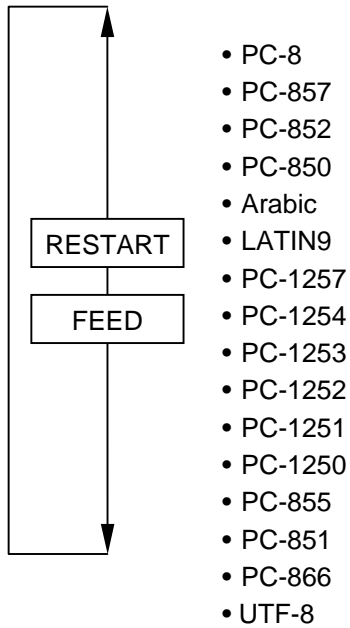

#### (2) Font "0" (ZERO FONT)

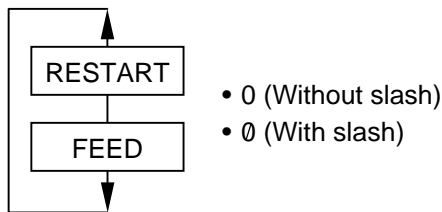

**NOTE:** The following fonts do not support a zero with a slash. Therefore, even if a zero with a slash is selected, a zero without a slash is used.

*[Bit map fonts]*

*OCR-A, OCR-B, GOTHIC725 Black, Kanji, Chinese Kanji*

*[Outline fonts]*

*Price fonts 1, 2, and 3, DUTCH801 Bold, BRUSH738 Regular, GOTHIC725 Black, TrueType font*

#### (3) RS-232C communication speed (SPEED)

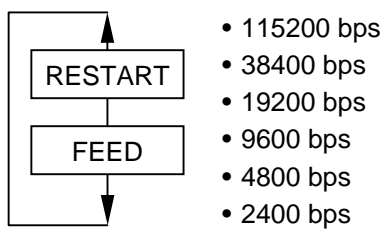

(4) RS-232C data length (DATA LENG.)

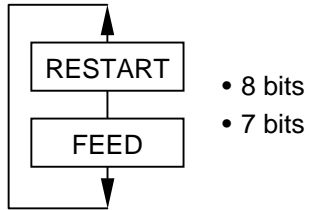

(5) RS-232C stop bit length (STOP BIT)

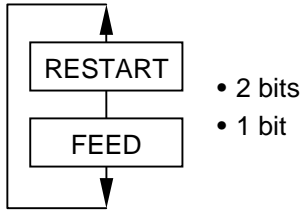

(6) RS-232C parity (PARITY)

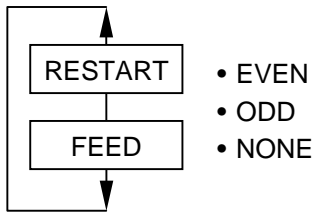

(7) RS-232C flow control method (XON/XOFF, READY/BUSY)

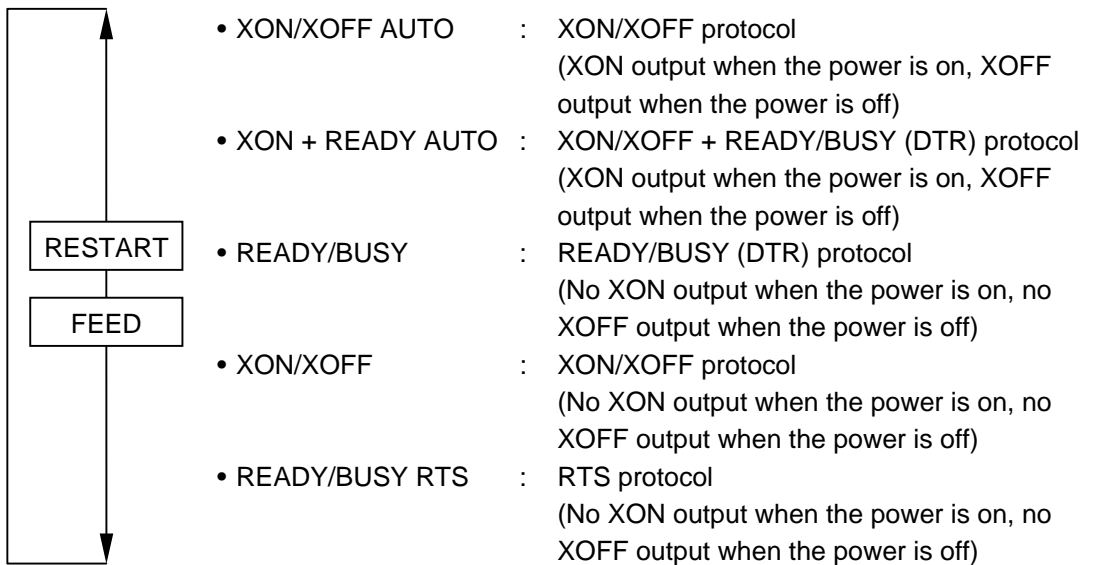

(8) Language for LCD messages (LCD)

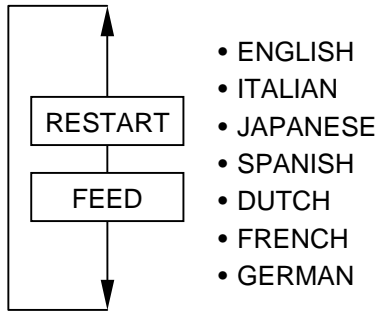

(9) Forward feed standby after an issue (FORWARD WAIT)

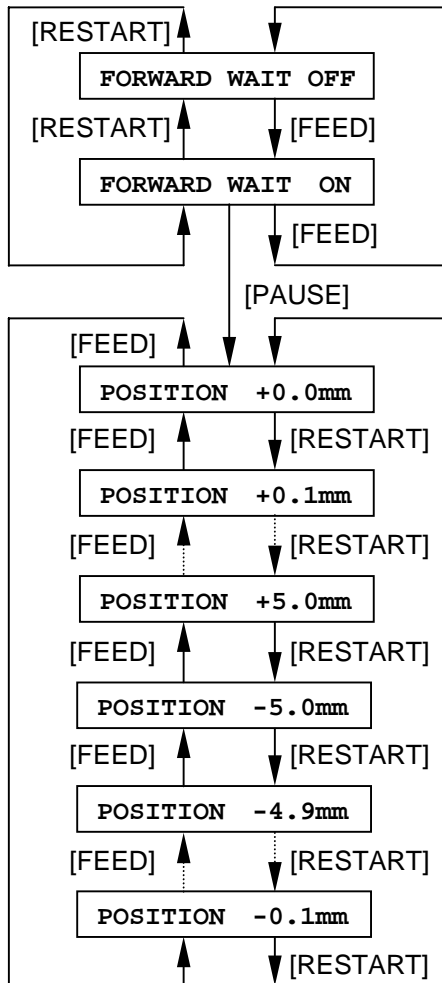

- OFF: Disabled
- ON: Enabled

Setting for a fine adjustment value for a stop position after a forward feed standby:

- 5.0 mm to +5.0 mm
- +: Performs a longer length of a forward feed, then stops.
- : Performs a shorter length of a forward feed, then stops.

(10) Control code (CODE)

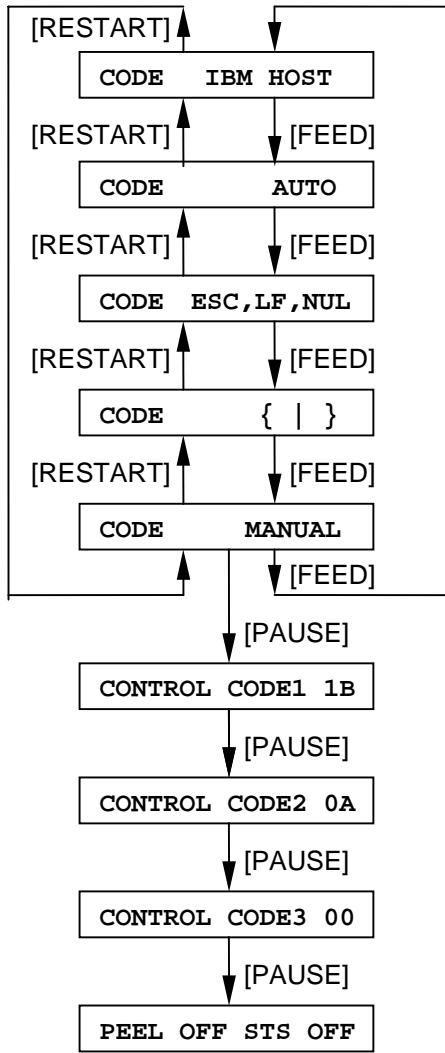

NOTE: IBM HOST is only for the Japan model.

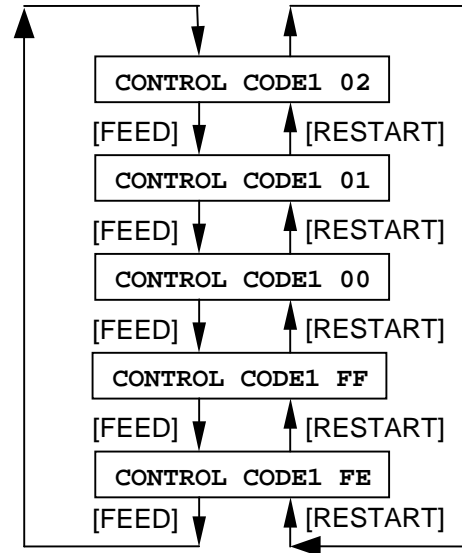

(11) Strip wait status (PEEL OFF STS)

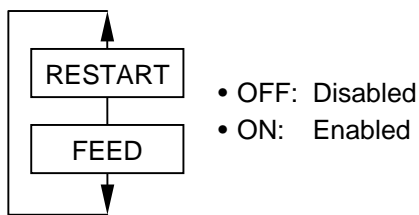

(12) [FEED] key function (FEED KEY)

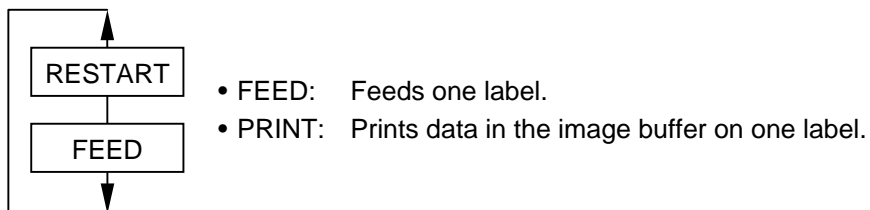

(13) Kanji code (KANJI CODE)

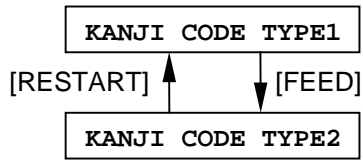

TYPE 1: For Windows codes

TYPE 2: For original codes

(14) Euro code (EURO CODE)

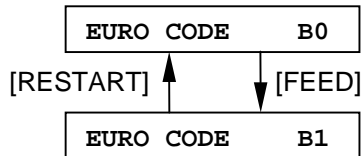

20H



FFH

(15) Automatic head broken dots check (AUTO HD CHK)

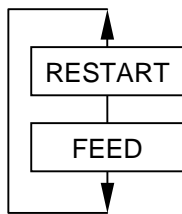

- OFF: A head broken dots check is not automatically performed when the power is turned on.
- ON: A head broken dots check is automatically performed when the power is turned on.

(16) Centronics ACK/BUSY timing (ACK/BUSY)

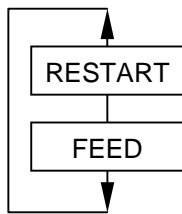

- TYPE 1 BUSY goes low at the same time as when ACK goes high.
- TYPE 2 BUSY goes high at the same time as when ACK goes low.

(17) Web printer function (WEB PRINTER)

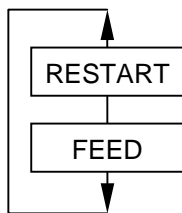

- OFF: Web printer function is disabled.
- ON: Web printer function is enabled.

(18) Reset process when the nInit signal is ON (INPUT PRIME)

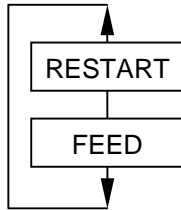

- OFF: The reset process is not performed.
- ON: The reset process is performed.

(19) Ribbon near end detection (RBN NEAR END)

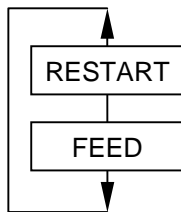

- 70 m: A ribbon near end state is detected when the remaining ribbon length is approximately 70 m.
- 30 m: A ribbon near end state is detected when the remaining ribbon length is approximately 30 m.
- OFF: A ribbon near end state is not detected.

**NOTE:** *There are some variations in detecting a ribbon near end state. It is preferable to use this setting for reference purposes.*

(20) Expansion I/O operation mode (EX. I/O)

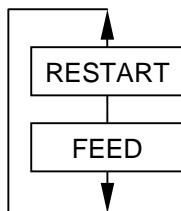

- TYPE1: Standard mode
- TYPE2: In-line mode

(21) Plug-and-play operation (PLUG & PLAY)

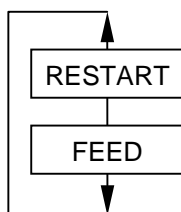

- OFF: A plug-and-play operation is disabled.
- ON: A plug-and-play operation is enabled.

**NOTE:** *In the USB interface, plug-and-play operations are always enabled, regardless of this setting.*

(22) Label end/ribbon error process (LBL/RBN END)

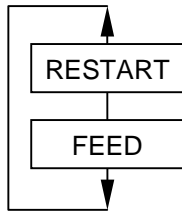

- TYP1: When a label end or ribbon error state is detected, the printer stops even if it is printing.
- TYP2: When a label end or ribbon error state is detected, the printer prints the current label as far as possible, then stops.

- TYP1: When a label end or a ribbon error is detected in the middle of printing, the printing immediately stops. When the printer is restarted, it feeds a paper first, then resumes the printing from the label at which the error occurred.

- TYP2: [Label end]

When a label end is detected in the middle of printing, the printer completes printing the current label, then stops operation when the next label is fed to the home position, displaying an error message, "NO PAPER X". ("X" indicates the number of remaining labels to be printed.)

[Number of remaining labels to be printed] = [Total number of labels to be printed] - [Number of printed labels including the label at which the error occurred]

When a label end is detected while the printer is printing a last label to be printed, "X" in the error message will be blank.

When the printer is restarted, the printer feeds a paper first, then resumes printing from the label after the one at which the error occurred. When the printer has already completed printing the last label to be printed, it only feeds a paper, then sends an End of Feed status and an End of Issue status, if the status response parameter is set to ON.

[Ribbon error]

- When a ribbon error is detected where the remaining label length is 30 mm or more, the printer continues to print for 20 mm and stops, displaying an error message "RIBBON ERROR X". ("X" indicates the number of remaining labels to be printed.)

[Number of remaining labels to be printed] = [Total number of labels to be printed] - [Number of printed labels] - 1

When a ribbon error is detected while the printer is printing a last label to be printed, "X" in the error message will be blank.

When the printer is restarted, the printer feeds a paper first, then resumes printing from the label after the one at which the error occurred. When the printer has already completed printing the last label to be printed, it only feeds a paper.



- When a ribbon error is detected where the remaining label length is less than 30 mm, the printer completes printing the current label, then stops operation when the next label is fed to the home position, displaying an error message, "RIBBON ERROR X". ("X" indicates the number of remaining labels to be printed.)  

$$[\text{Number of remaining labels to be printed}] = [\text{Total number of labels to be printed}] - [\text{Number of printed labels including the label at which the error occurred}]$$
When a ribbon error is detected while the printer is printing a last label to be printed, "X" in the error message will be blank.  
When the printer is restarted, the printer feeds a paper first, then resumes printing from the label after the one at which the error occurred. When the printer has already completed printing the last label to be printed, it only feeds a paper, then sends an End of Feed status and an End of Issue status, if the status response parameter is set to ON.

### Examples of LBL/RBN END TYP2

[Case 1] Number of total labels to be printed = 5

A label end is detected while the 3rd label is printed.

(1st)(2nd)(3rd)

↑

After issuing the 3rd label completely, the printer stops, displaying "NO PAPER 2".

When the printer is restarted, the printer feeds a paper, then prints on the 4th and 5th labels. All 5 labels are printed.

[Case 2] Number of total labels to be printed = 5

A ribbon error is detected while the 3rd label is printed.

The remaining label length is 30 mm or more.

(1st)(2nd)(3rd)

↑

After the 3rd label is printed for 20 mm, the printer stops printing, displaying "RIBBON ERROR 2".

When the printer is restarted, the printer feeds a paper, then prints on the 4th and 5th labels. The 1st, 2nd, 4th, and 5th labels are printed.

[Case 3] Number of total labels to be printed = 5

A ribbon error is detected while the 3rd label is printed.

The remaining label length is less than 30 mm.

(1st)(2nd)(3rd)

↑

After issuing the 3rd label completely, the printer stops, displaying "RIBBON ERROR 2".

When the printer is restarted, the printer feeds a paper, then prints on the 4th and 5th labels. All 5 labels are printed.

(23) Pre-strip process (PRE PEEL OFF)

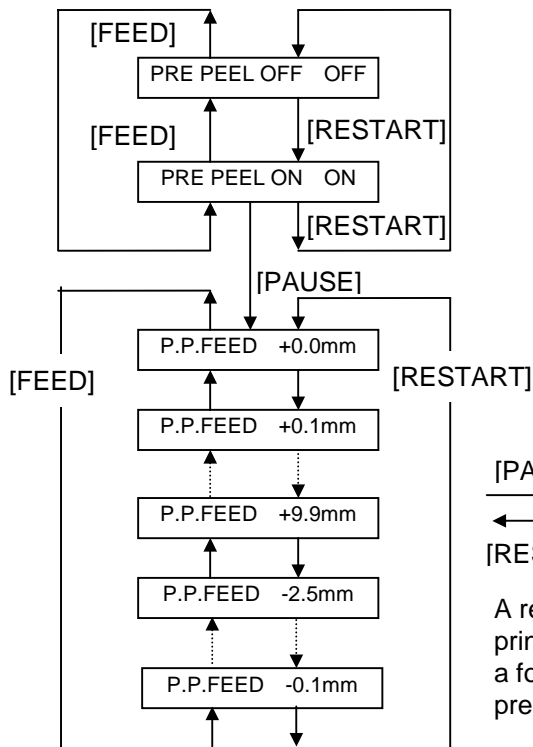

- OFF: The pre-strip function is enabled.
- ON: The pre-strip function is disabled.

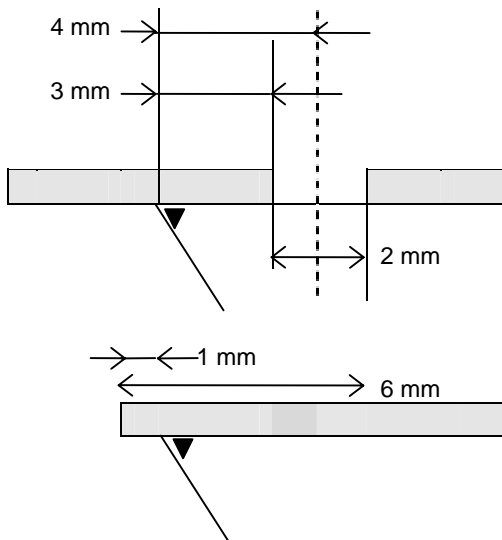
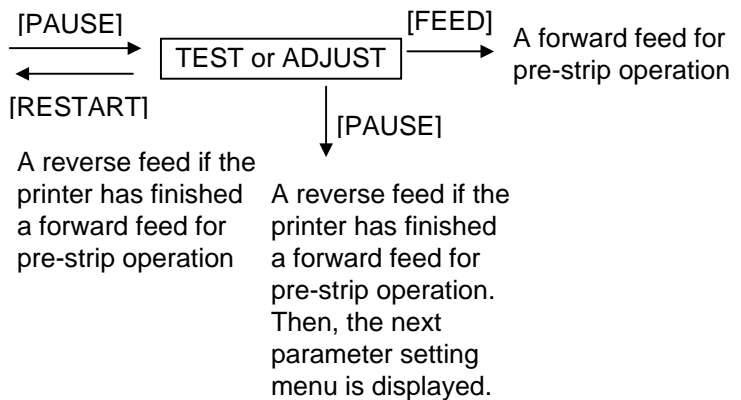

The print stop position in strip issue mode is designed in a manner so that printing stops when the distance from the middle of the gap between labels to the end of the strip shaft is 4 mm.

Assuming the label gap is 2 mm, the initial pre-strip distance is designed to be 6 mm for the reason that the optimal label length that is fed past the strip shaft by the pre-strip process (= label length to be pre-stripped) is 1.0 mm to 2.0 mm.

But when the gap is more than 2 mm and the above-mentioned print stop position is not proper, the print stop position should be adjusted using the strip position fine adjust function.

In order to find a proper fine adjustment value, a test print is available after a feed amount fine adjustment for the pre-strip function. If the label leading edge aligns with the end of the strip shaft, it means actual pre-strip forward/reverse feed amount is proper.

(24) Reverse feed speed (BACK SPEED)

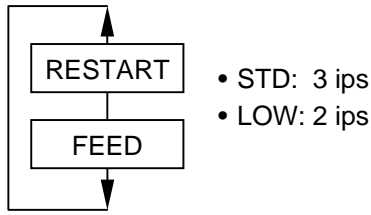

(25) MaxiCode specification (MAXI CODE)

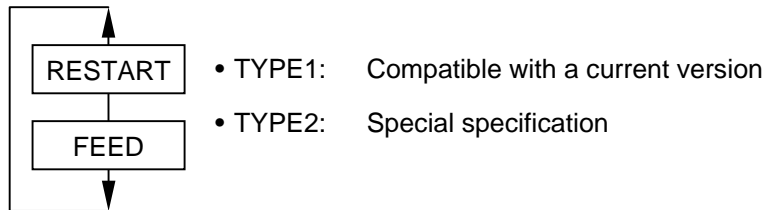

A mode specified by a command may be different from an actual mode, depending on the status of this parameter. Also, the data transmission method differs partly. For details, refer to the B-SA4T External Equipment Interface Specification.

(26) Keyboard I/F (KB I/F)

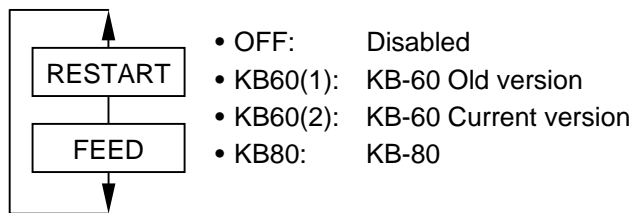

(26) Keyboard I/F (KB I/F)

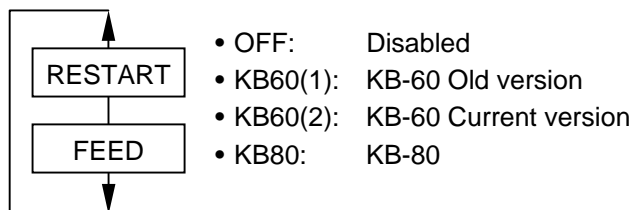

(27) Strip motor torque (PEEL OFF TRQ)

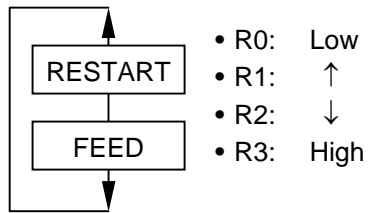

(28) Print head applied current table setting (TONE TABLE)

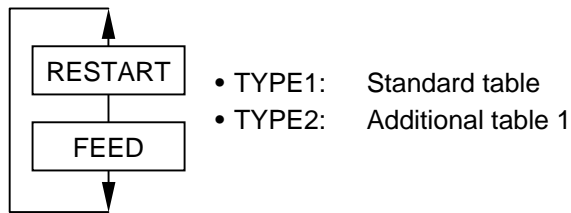

Supplementary explanations

- When the [RESTART] and [FEED] keys are pressed at the same time, the display returns to the System mode menu display.
- If the [RESTART] or [FEED] key is held down for 0.5 seconds or more when a parameter is being set, the printer enters repeat mode, in which the key is entered repeatedly.
- A changed parameter is stored in memory by pressing the [PAUSE] key.

## 6.4 FINE ADJUSTMENT VALUE SETTING

### 6.4.1 Fine Adjustment Value Setting Operation Example

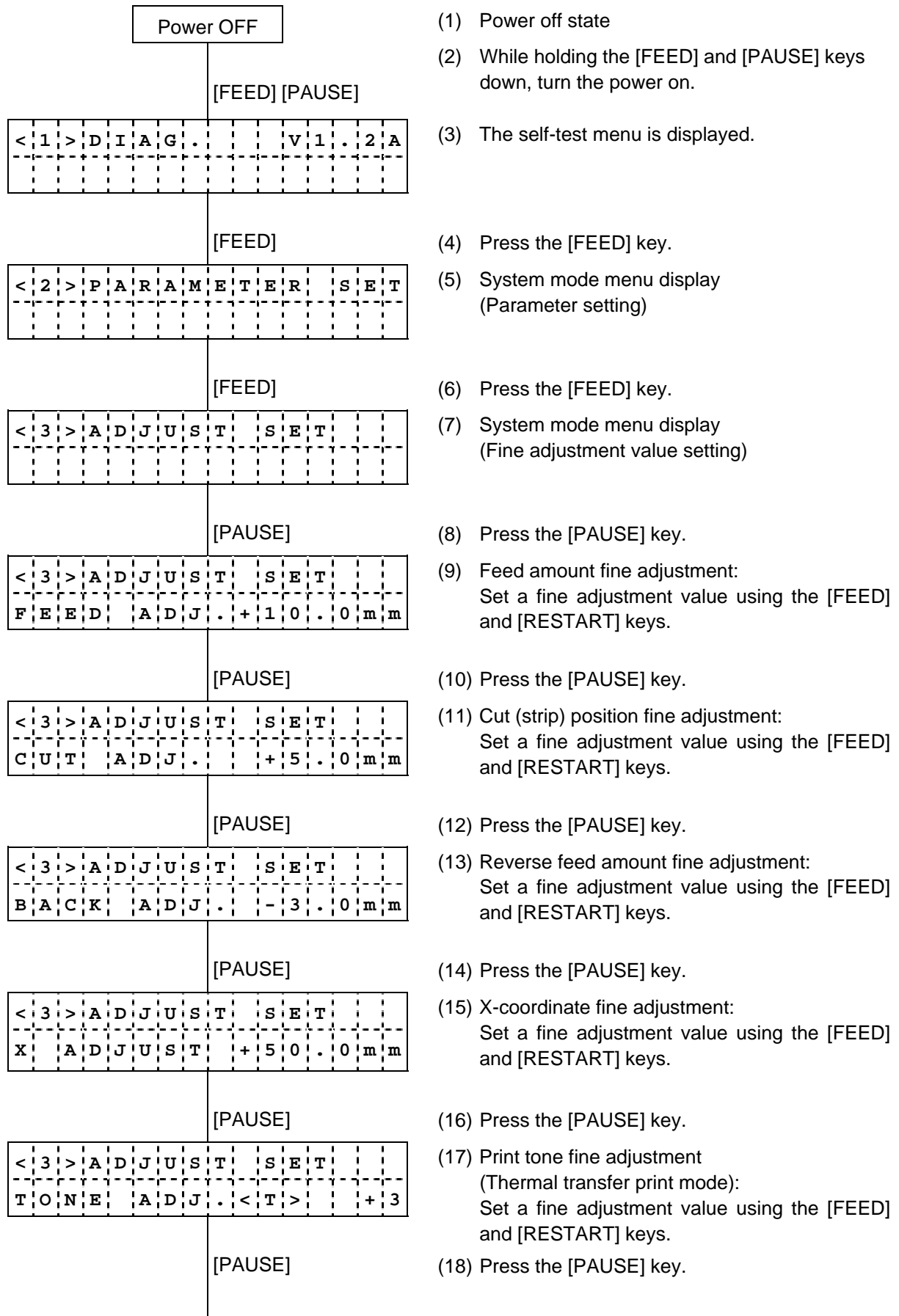

|   |   |   |   |   |   |   |   |   |   |   |   |   |   |
|---|---|---|---|---|---|---|---|---|---|---|---|---|---|
| < | 3 | > | A | D | J | U | S | T | S | E | T |   |   |
| T | O | N | E | A | D | J | . | < | D | > |   | - | 2 |

[PAUSE]

|   |   |   |   |   |   |   |   |   |   |   |   |   |     |
|---|---|---|---|---|---|---|---|---|---|---|---|---|-----|
| < | 3 | > | A | D | J | U | S | T | S | E | T |   |     |
| R | B | N | A | D | J |   | < | F | W | > |   | - | 1 0 |

[PAUSE]

|   |   |   |   |   |   |   |   |   |   |   |   |   |   |
|---|---|---|---|---|---|---|---|---|---|---|---|---|---|
| < | 3 | > | A | D | J | U | S | T | S | E | T |   |   |
| R | B | N | A | D | J |   | < | B | K | > |   | - | 5 |

[PAUSE]

|   |   |   |   |   |   |   |   |   |   |   |   |   |       |
|---|---|---|---|---|---|---|---|---|---|---|---|---|-------|
| < | 3 | > | A | D | J | U | S | T | S | E | T |   |       |
| T | H | R | E | S | H | O | L | D | < | R | > | 1 | . 0 V |

[PAUSE]

|   |   |   |   |   |   |   |   |   |   |   |   |   |       |
|---|---|---|---|---|---|---|---|---|---|---|---|---|-------|
| < | 3 | > | A | D | J | U | S | T | S | E | T |   |       |
| T | H | R | E | S | H | O | L | D | < | T | > | 1 | . 4 V |

[PAUSE]

|   |   |   |   |   |   |   |   |   |   |   |   |  |  |
|---|---|---|---|---|---|---|---|---|---|---|---|--|--|
| < | 3 | > | A | D | J | U | S | T | S | E | T |  |  |
|   |   |   |   |   |   |   |   |   |   |   |   |  |  |

- (19) Print tone fine adjustment  
(Direct thermal print mode):  
Set a fine adjustment value using the [FEED] and [RESTART] keys.
- (20) Press the [PAUSE] key.
- (21) Ribbon motor drive voltage fine adjustment  
(Take-up):  
Set a fine adjustment value using the [FEED] and [RESTART] keys.
- (22) Press the [PAUSE] key.
- (23) Ribbon motor drive voltage fine adjustment  
(Feed):  
Set a fine adjustment value using the [FEED] and [RESTART] keys.
- (24) Press the [PAUSE] key.
- (25) Reflective sensor manual threshold fine adjustment:  
Set a fine adjustment value using the [FEED] and [RESTART] keys.
- (26) Press the [PAUSE] key.
- (27) Transmissive sensor manual threshold fine adjustment:  
Set a fine adjustment value using the [FEED] and [RESTART] keys.
- (28) Press the [PAUSE] key.
- (29) The fine adjustment value setting menu is displayed.

## 6.4.2 Details of Fine Adjustment Value Setting

### (1) Feed amount fine adjustment (FEED ADJ.)

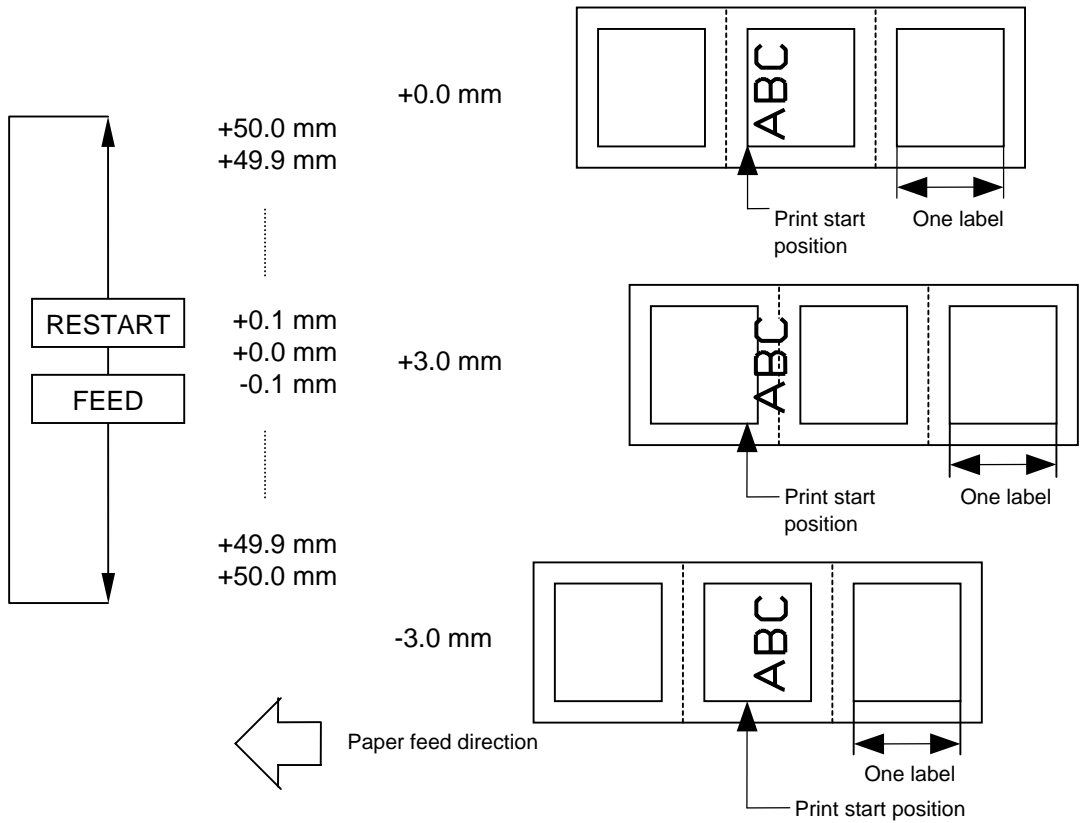

### (2) Cut (strip) position fine adjustment (CUT ADJ.)

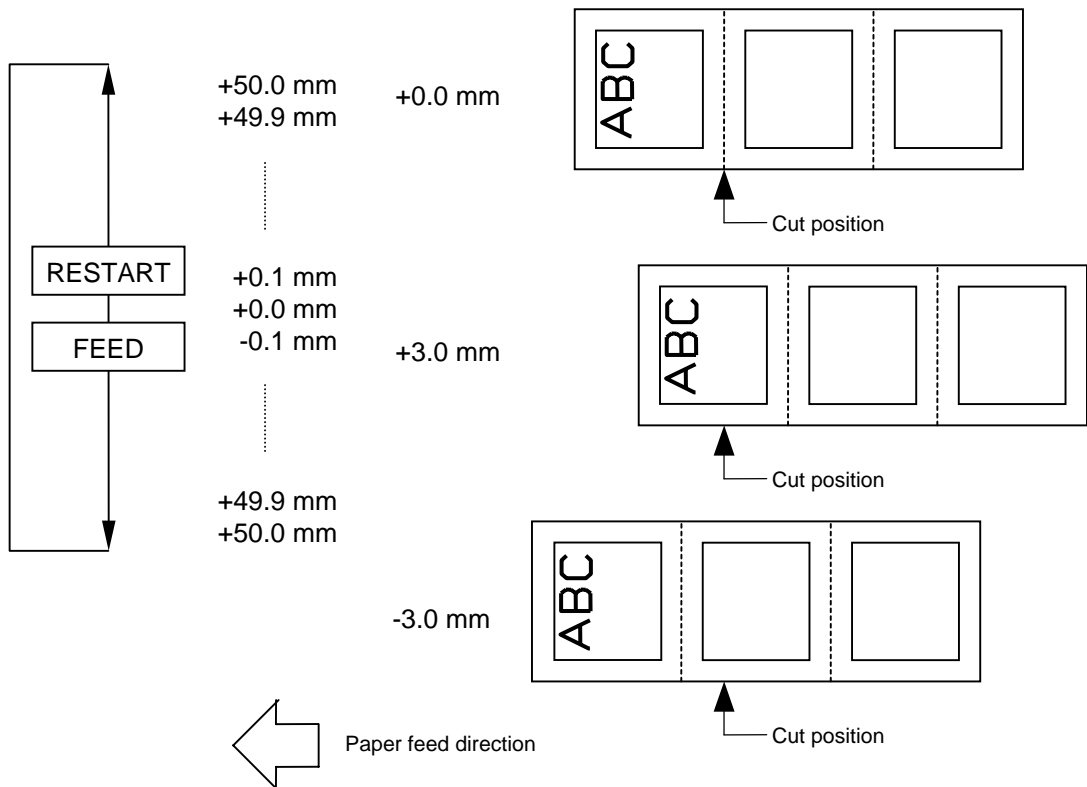

[Handling of label papers having the label pitch of less than 22 mm in cut issue mode]

The minimum label pitch in normal cut issue mode is 22.0 mm. When a label paper having the label pitch of less than 22.0 mm is used (although it is out of specification), an edge of a label is caught by an edge of the thermal head during a reverse feed to the home position after the paper is cut in a gap area between labels. This may prevent the label from being fed back to the proper home position. In such a case, perform the method below to solve the problem.

[Method] Adjust the cut position fine adjustment value.

When this method is used, one or more printed labels are left between the head and the cutter, which should be removed by an issue or a label feed.

(a) Calculation of cut position fine adjustment value

The cut position fine adjustment value is calculated using the following formula. If the paper still is not fed back to the proper home position using the value obtained, the cut position should be adjusted using any other value.

$$\begin{aligned} \text{Cut position fine adjustment value} &= (\text{Number of labels left between head and cutter}) \times (\text{Label pitch}) \\ &= \left( \frac{22.0 \text{ mm}}{\text{Label pitch}} \right) \times (\text{Label pitch}) \end{aligned}$$

\* Any decimal remainders are dropped.

Ex) Label pitch: 20.0 mm

$$\begin{aligned} \text{Cut position fine adjustment value} &= \left( \frac{22.0 \text{ mm}}{20.0 \text{ mm}} \right) \times (20.0 \text{ mm}) \\ &= 1 \times 20.0 \text{ mm} \\ &= +20.0 \text{ mm} \end{aligned}$$



(b) Operation example

Issue count: 2, Cut interval = 1

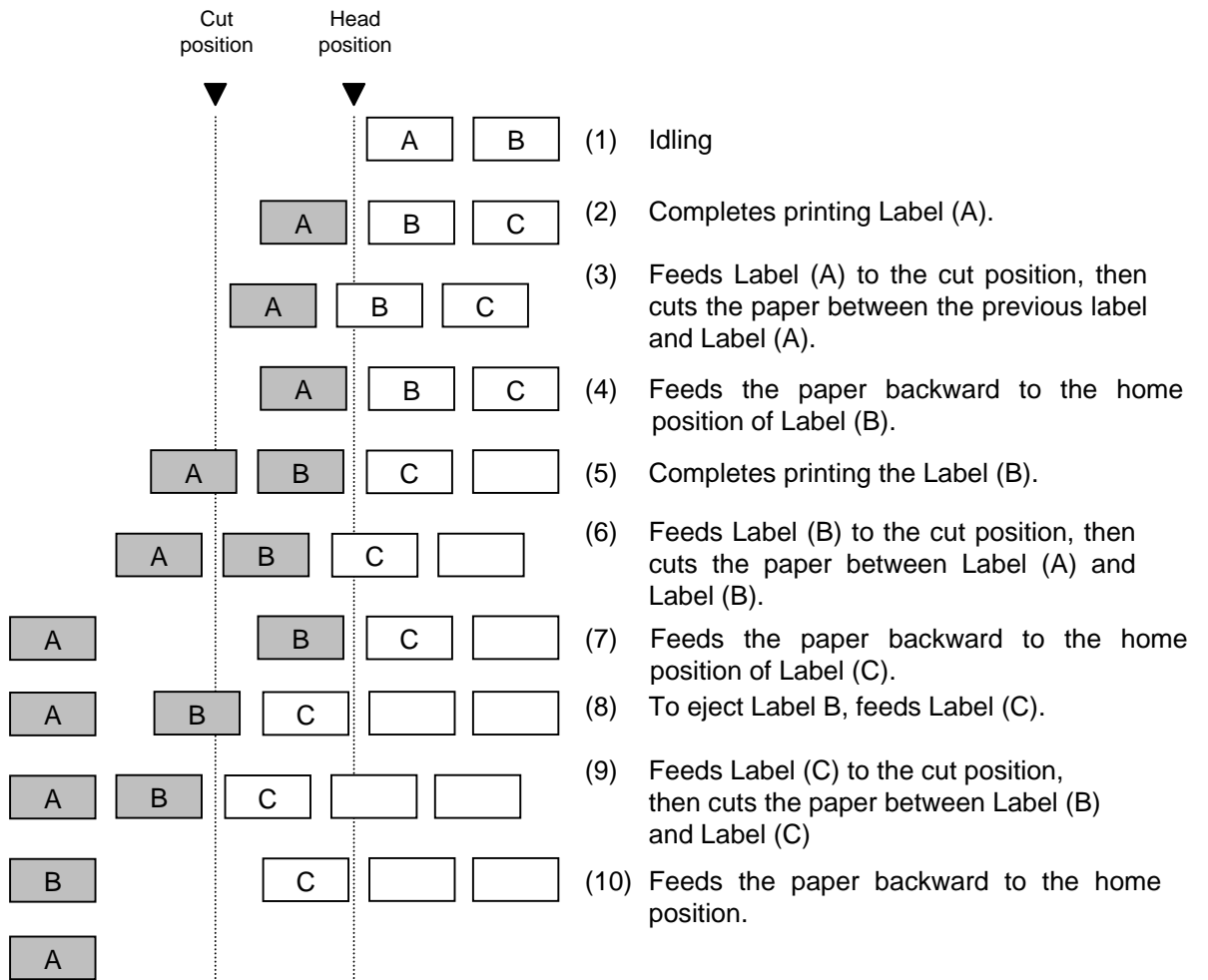

[Strip position fine adjustment]

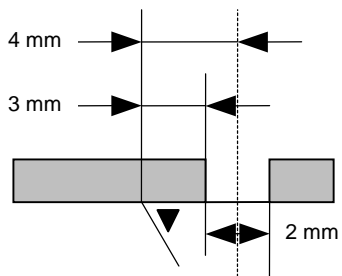
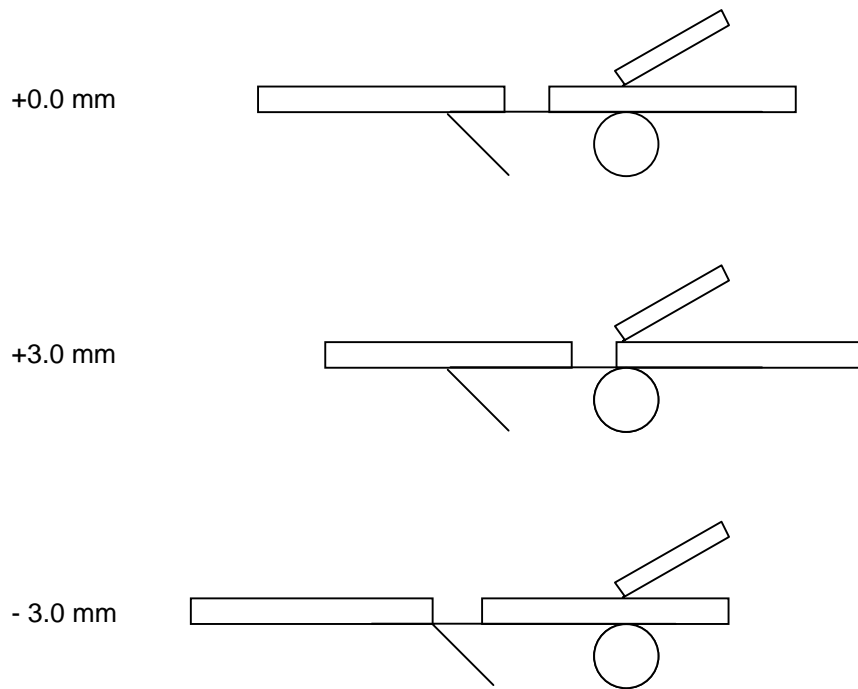

Assuming the label gap is 2 mm, the print stop position in strip issue mode is designed in a manner so that printing stops when the distance from the middle of the gap between labels to the end of the strip shaft is 4 mm.

When the gap is more than 2 mm and the above-mentioned print stop position is not proper, the print stop position should be adjusted using the strip position fine adjust function.

(3) Reverse feed amount fine adjustment (BACK ADJ.)

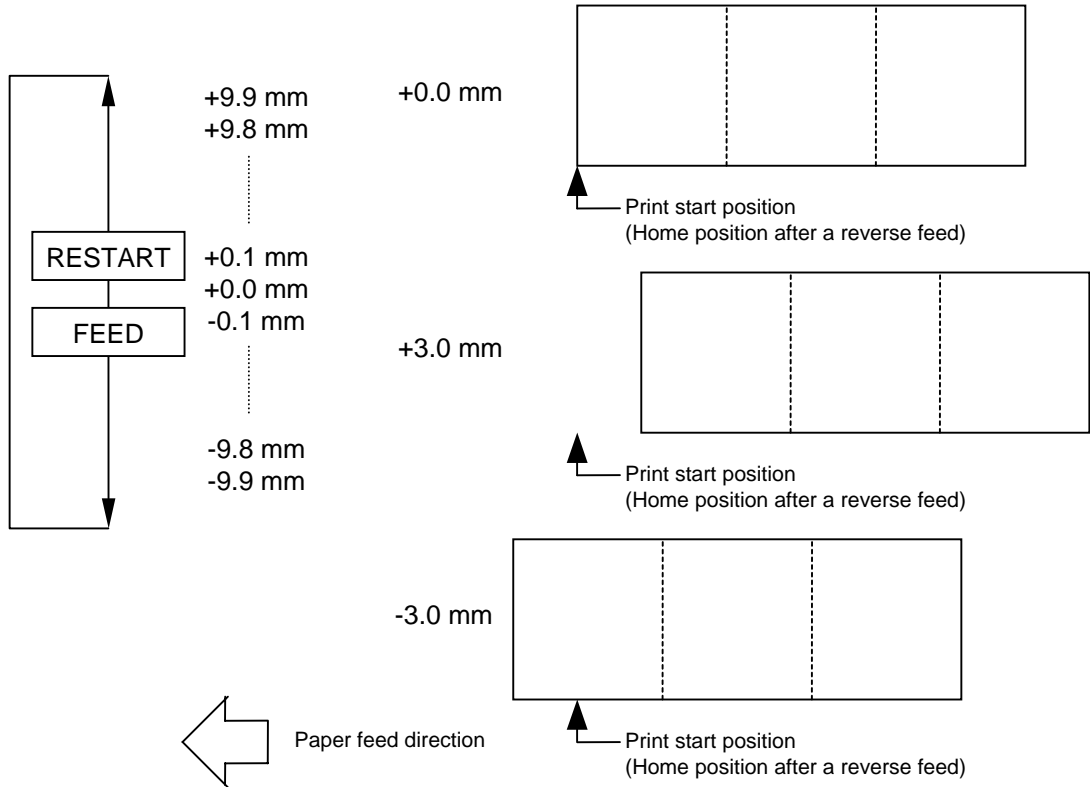

**NOTE:** There may be cases where a label is not returned to the home position depending on the print conditions, even if a reverse feed amount is the same as a forward feed amount.

When an operation including reverse feed (cut issue, strip issue, forward feed standby after an issue) is performed using a sensor, a label/tag may not be returned to the home position resulting an error, if the label pitch length is almost the same as the distance between the thermal print head and the paper sensor (69.8 mm). To prevent this problem, the reverse feed amount should be increased by performing the reverse feed fine adjustment in the + direction.

(4) X-coordinate fine adjustment (X ADJUST.)

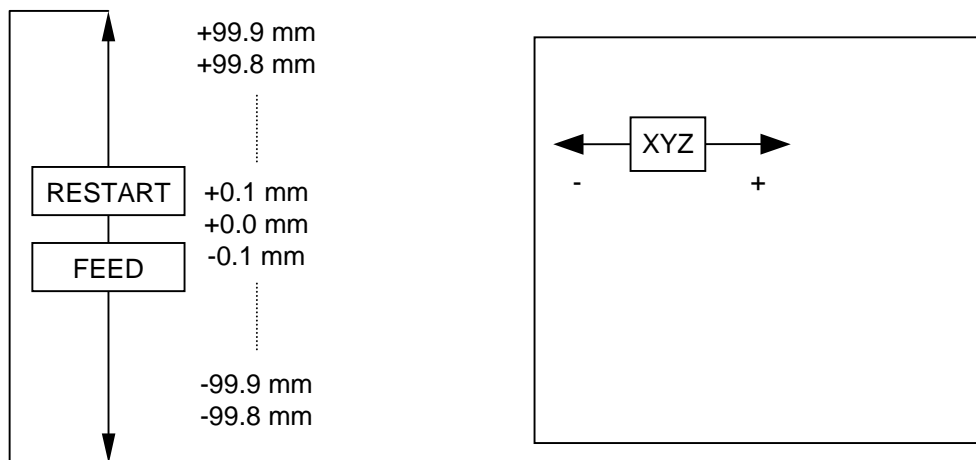

(5) Print tone fine adjustment (Thermal transfer/direct thermal) (TONE ADJ.)

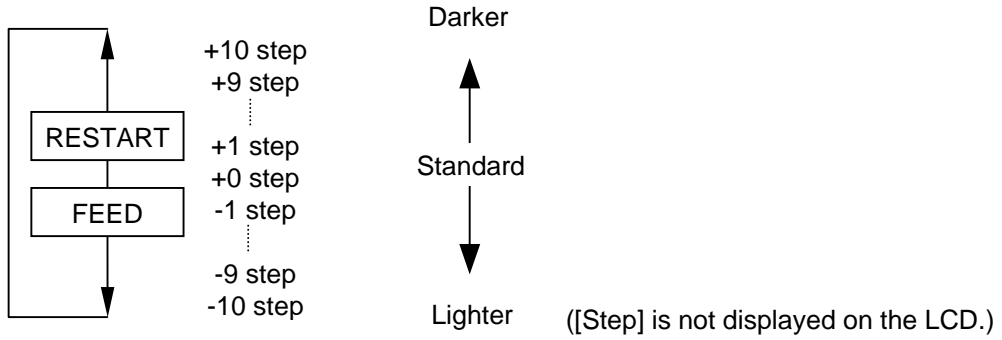

(6) Ribbon motor drive voltage fine adjustment (Take-up) (RBN ADJ <BK>)

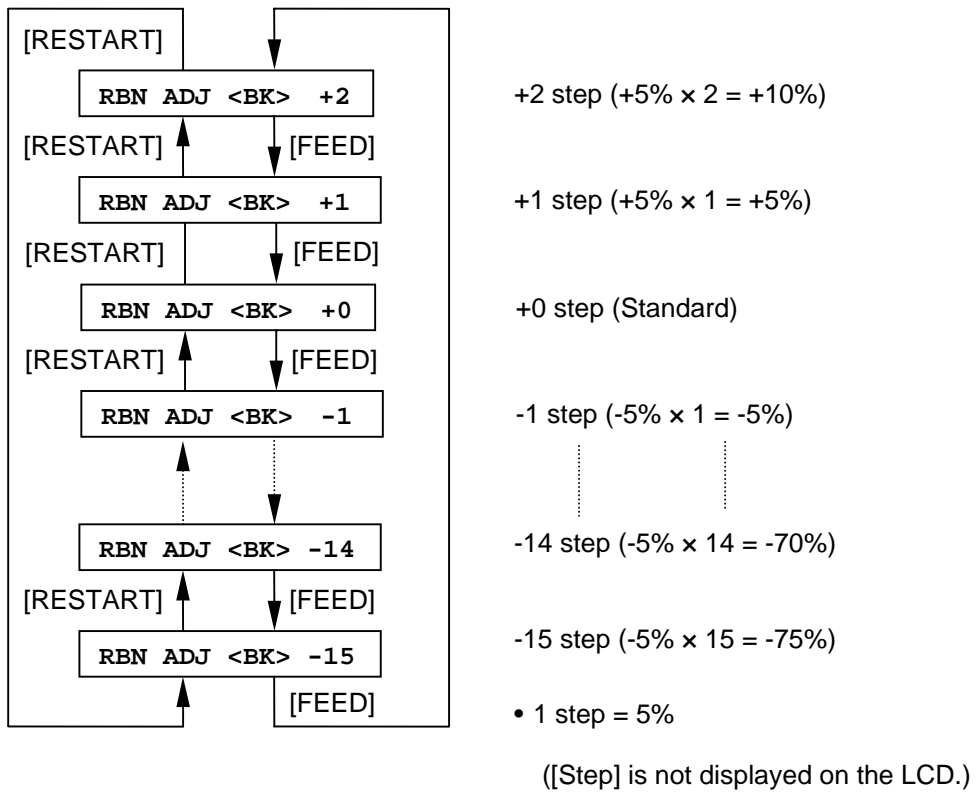

(7) Ribbon motor drive voltage fine adjustment (Feed) (RBN ADJ <BK>)

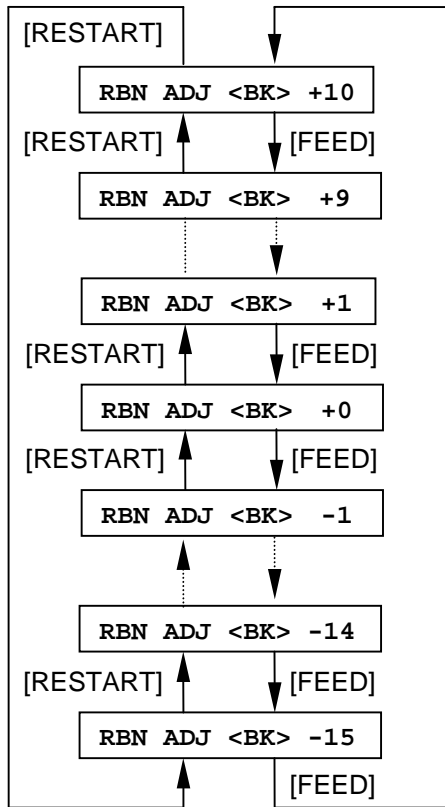

+10 step (+5% × 10 = +50%)

+9 step (+5% × 9 = +45%)

+1 step (+5% × 1 = +5%)

+0 step (Standard)

-1 step (-5% × 1 = -5%)

-14 step (-5% × 14 = -70%)

-15 step (-5% × 15 = -75%)

• 1 step = 5%

([Step] is not displayed on the LCD.)

(8) Transmissive sensor manual threshold fine adjustment (THRESHOLD<T>)

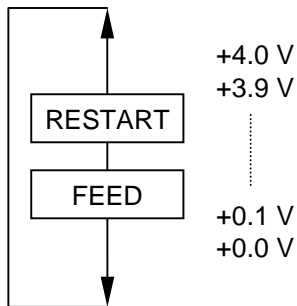

**NOTE:** If "0.0 V" is set, the value "0.0 V" is returned to the value (1.0 V) after the power is turned off and on again.

(9) Reflective sensor manual threshold fine adjustment (THRESHOLD<R>)

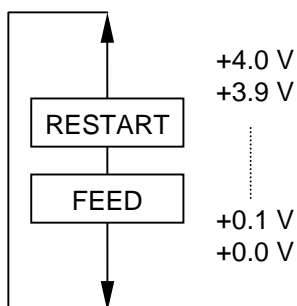

**NOTE:** If "0.0 V" is set, the value "0.0 V" is returned to the value (1.4 V) after the power is turned off and on again.

## Supplementary explanations

- When the [RESTART] and [FEED] keys are pressed at the same time, the display shows the system mode menu.
- If the [RESTART] or [FEED] key is held down for 0.5 seconds when a fine adjustment value is being set, the printer enters repeat mode, in which the key is entered repeatedly.
- A changed fine adjustment value is stored in memory by pressing the [PAUSE] key.
- The printer is controlled by a sum of a fine adjustment parameter value programmed on the printer and a fine adjustment command value from the PC. The maximum value for each fine adjustment is as follows:
  - Feed fine adjustment ..... ±50.0 mm
  - Strip position fine adjustment ..... ±50.0 mm
  - Back feed fine adjustment ..... ±9.9 mm
  - Print density fine adjustment ..... ±10 step
  - X-coordinate fine adjustment ..... ±99.9 mm
  - Ribbon motor drive voltage fine adjustment (Take-up) ..... -15 to +2 step
  - Ribbon motor drive voltage fine adjustment (Feed) ..... -15 to +10 step
- An X-coordinate fine adjustment is performed to finely adjust the X-coordinate of a drawing in the left or right direction in an effective print width range. (Even if a value is set to less than 0 as a result of the fine adjustment, the value is set to 0.)
- An X-coordinate fine adjustment is not effective for self-test print (maintenance counter values, various parameter values, and automatic self-test) and other test print.
- A print tone fine adjustment value is +0 step at the time of shipment from the factory.
- A ribbon take-up/feed motor drive voltage fine adjustment value is a sum of a fine adjustment value by a command (from the PC) and a fine adjustment value in the system mode (by key operation). The maximum fine adjustment value is -15 for both the ribbon take-up motor and the ribbon feed motor.
- A print tone fine adjustment value is a sum of a fine adjustment value by a command (from the PC) and a fine adjustment value in system mode (by key operation). The maximum value for each print speed, 203 dpi and 300 dpi, is as below. When the value exceeds the maximum, it is automatically corrected to the maximum.

| Print Speed | 203 dpi        |                  | 300 dpi        |                  |
|-------------|----------------|------------------|----------------|------------------|
|             | Thermal direct | Thermal transfer | Thermal direct | Thermal transfer |
| 2 ips       | +10 step       | +10 step         | +10 step       | +10 step         |
| 4 ips       | +8 step        | +10 step         | +8 step        | +10 step         |
| 6 ips       | +8 step        | +10 step         | +8 step        | +10 step         |

## 6.5 TEST PRINT

### 6.5.1 Test Print Operation Example

(1) Normal test print

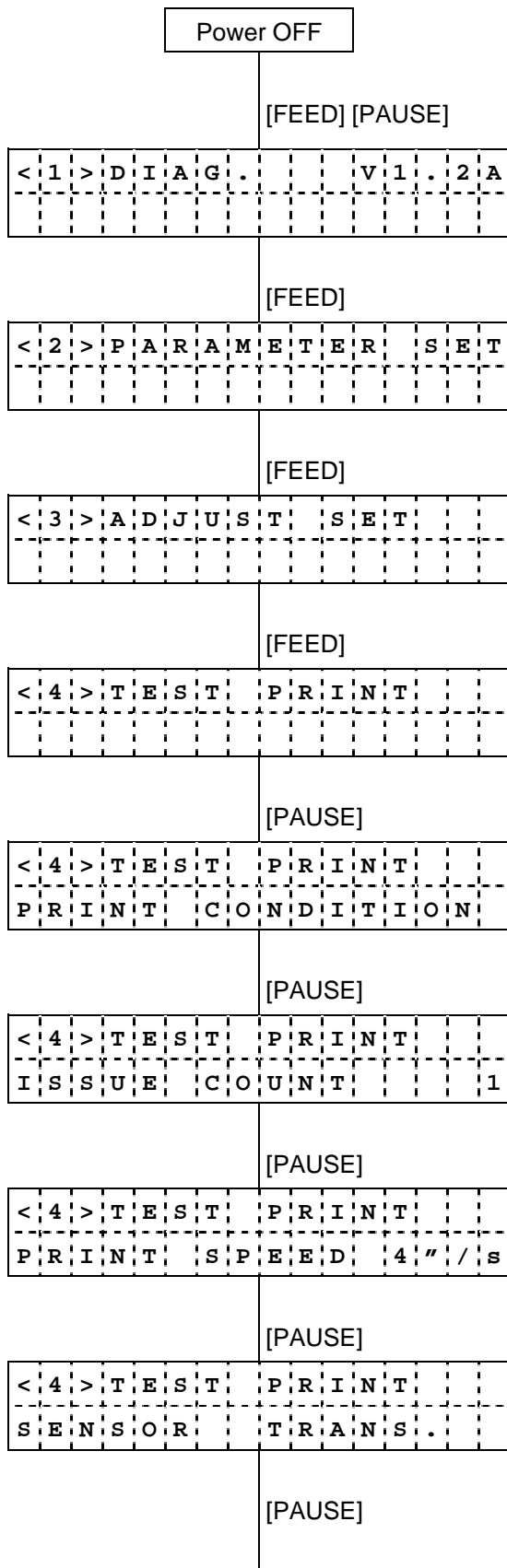

- (1) Power off state
- (2) While holding the [FEED] and [PAUSE] keys down, turn the power on.
- (3) The self-test menu is displayed.
- (4) Press the [FEED] key.
- (5) System mode menu display (Parameter setting)
- (6) Press the [FEED] key.
- (7) System mode menu display (Fine adjustment value setting)
- (8) Press the [FEED] key.
- (9) System mode menu display (Test print)
- (10) Press the [PAUSE] key.
- (11) Test print condition setting mode
- (12) Press the [PAUSE] key.
- (13) Issue count setting mode:  
Select an issue count using the [FEED] and [RESTART] keys.
- (14) Press the [PAUSE] key.
- (15) Print speed setting mode:  
Select a print speed using the [FEED] and [RESTART] keys.
- (16) Press the [PAUSE] key.
- (17) Sensor setting mode:  
Select a sensor using the [FEED] and [RESTART] keys.
- (18) Press the [PAUSE] key.

```
< 4 > T E S T P R I N T
P R T T Y P E T R A N S F R
```

(19) Print type setting mode:  
Select a print type using the [FEED] and [RESTART] keys.

[PAUSE]

(20) Press the [PAUSE] key.

```
< 4 > T E S T P R I N T
T Y P E [ S ] N O C U T
```

(21) Issue type setting mode:  
Select a issue type using the [FEED] and [RESTART] keys.

[PAUSE]

(22) Press the [PAUSE] key.

```
< 4 > T E S T P R I N T
L A B E L L E N . 7 6 m m
```

(23) Label length setting mode:  
Select a label length using the [FEED] and [RESTART] keys.

[PAUSE]

(24) Press the [PAUSE] key.

```
< 4 > T E S T P R I N T
P A P E R F E E D
```

(25) One label feed mode:  
Select a mode using the [FEED] and [RESTART] keys.

[PAUSE]

(26) Press the [PAUSE] key.

(One label is fed.)

```
< 4 > T E S T P R I N T
```

(27) System mode menu display  
(Test print)

[PAUSE]

(28) Press the [PAUSE] key.

```
< 4 > T E S T P R I N T
P R I N T C O N D I T I O N
```

(29) Test print condition setting mode

[FEED]

(30) Press the [FEED] key.

```
< 4 > T E S T P R I N T
S L A N T L I N E ( 1 D O T )
```

(31) 1-dot slant line print mode

[FEED]

(32) Press the [FEED] key.

```
< 4 > T E S T P R I N T
S L A N T L I N E ( 3 D O T )
```

(33) 3-dot slant line print mode

[FEED]

(34) Press the [FEED] key.

```
< 4 > T E S T P R I N T
C H A R A C T E R S
```

(35) Character print mode

[PAUSE]

(36) Press the [PAUSE] key.  
(One label is printed.)

```
< 4 > T E S T P R I N T
```

(37) System mode menu display  
(Test print)



(2) Test print for assembly process

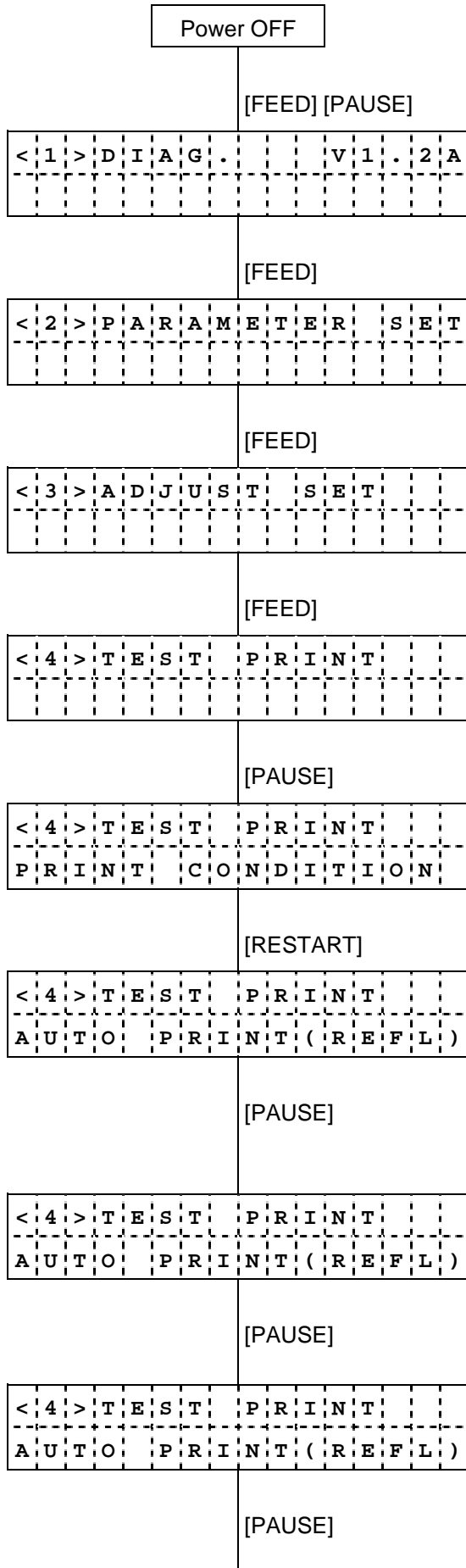

- (1) Power off state
- (2) While holding the [FEED] and [PAUSE] keys down, turn the power on.
- (3) The self-test menu is displayed.
- (4) Press the [FEED] key.
- (5) System mode menu display (Parameter setting)
- (6) Press the [FEED] key.
- (7) System mode menu display (Fine adjustment value setting)
- (8) Press the [FEED] key.
- (9) System mode menu display (Test print)
- (10) Press the [PAUSE] key.
- (11) Test print condition setting mode
- (12) Press the [RESTART] key.
- (13) Assembly process automatic print mode (Reflective sensor)
- (14) Press the [PAUSE] key.
 

|   |
|---|
| One label is fed.                       |
| 3-dot slant line: 5 labels are printed. |
- (15) Assembly process automatic print mode (Reflective sensor)
- (16) Press the [PAUSE] key. (Bar code: 5 labels are printed.)
- (17) Assembly process automatic print mode (Reflective sensor)
- (18) Press the [PAUSE] key. (Characters: 5 labels are printed.)

|   |   |   |   |   |   |   |   |   |   |   |   |  |  |  |  |  |  |  |  |
|---|---|---|---|---|---|---|---|---|---|---|---|--|--|--|--|--|--|--|--|
| < | 4 | > | T | E | S | T | P | R | I | N | T |  |  |  |  |  |  |  |  |
|   |   |   |   |   |   |   |   |   |   |   |   |  |  |  |  |  |  |  |  |

(19) System mode menu display  
(Test print)

[PAUSE]

(20) Press the [PAUSE] key.

|   |   |   |   |   |   |   |   |   |   |   |   |   |   |   |   |  |  |  |  |
|---|---|---|---|---|---|---|---|---|---|---|---|---|---|---|---|--|--|--|--|
| < | 4 | > | T | E | S | T | P | R | I | N | T |   |   |   |   |  |  |  |  |
| A | U | T | O |   | P | R | I | N | T | ( | T | R | A | N | ) |  |  |  |  |

(21) Assembly process automatic print mode  
(Transmissive sensor)

(22) Press the [PAUSE] key.

[ One label is fed.  
3-dot slant line: 5 labels are printed. ]

[PAUSE]

(23) Assembly process automatic print mode  
(Transmissive sensor)

|   |   |   |   |   |   |   |   |   |   |   |   |   |   |   |   |  |  |  |  |
|---|---|---|---|---|---|---|---|---|---|---|---|---|---|---|---|--|--|--|--|
| < | 4 | > | T | E | S | T | P | R | I | N | T |   |   |   |   |  |  |  |  |
| A | U | T | O |   | P | R | I | N | T | ( | T | R | A | N | ) |  |  |  |  |

(24) Press the [PAUSE] key.  
(Bar code: 5 labels are printed.)

[PAUSE]

(25) Assembly process automatic print mode  
(Transmissive sensor)

|   |   |   |   |   |   |   |   |   |   |   |   |   |   |   |   |  |  |  |  |
|---|---|---|---|---|---|---|---|---|---|---|---|---|---|---|---|--|--|--|--|
| < | 4 | > | T | E | S | T | P | R | I | N | T |   |   |   |   |  |  |  |  |
| A | U | T | O |   | P | R | I | N | T | ( | T | R | A | N | ) |  |  |  |  |

(26) Press the [PAUSE] key.  
(Characters: 5 labels are printed.)

[PAUSE]

(27) System mode menu display  
(Test print)

|   |   |   |   |   |   |   |   |   |   |   |   |  |  |  |  |  |  |  |  |
|---|---|---|---|---|---|---|---|---|---|---|---|--|--|--|--|--|--|--|--|
| < | 4 | > | T | E | S | T | P | R | I | N | T |  |  |  |  |  |  |  |  |
|   |   |   |   |   |   |   |   |   |   |   |   |  |  |  |  |  |  |  |  |

## 6.5.2 Details of Test Print Setting

### (1) Test print mode

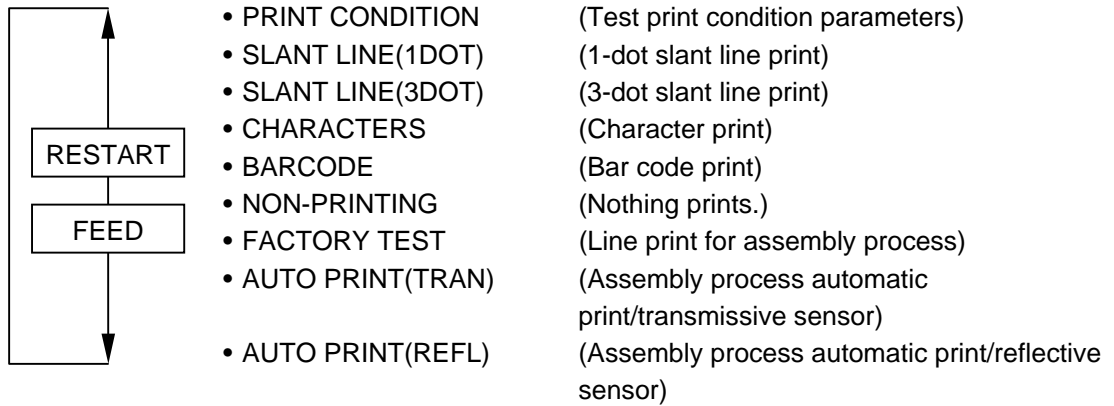

### (2) Test print condition parameters (PRINT CONDITION)

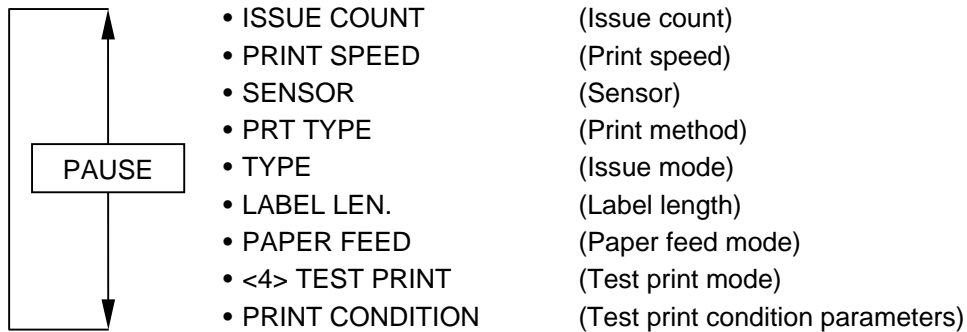

### (3) Issue count (ISSUE COUNT)

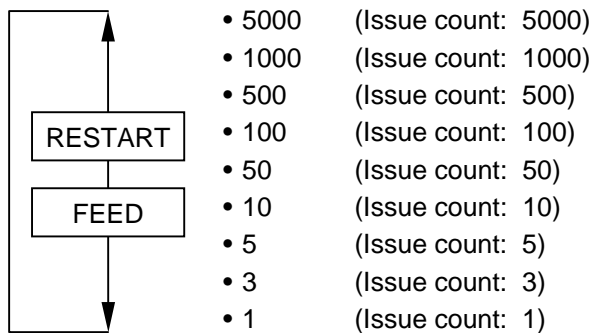

### (4) Print speed (PRINT SPEED)

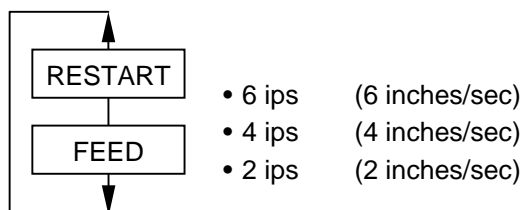

(5) Sensor (SENSOR)

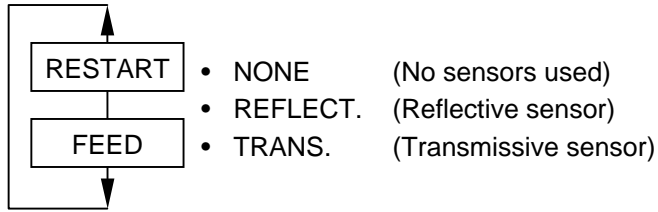

(6) Print type (PRT TYPE)

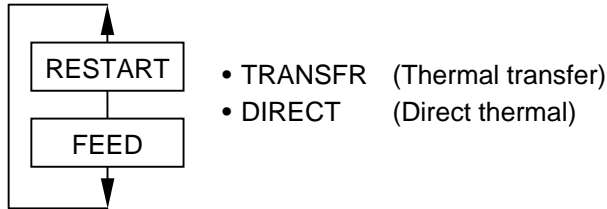

(7) Issue type (TYPE)

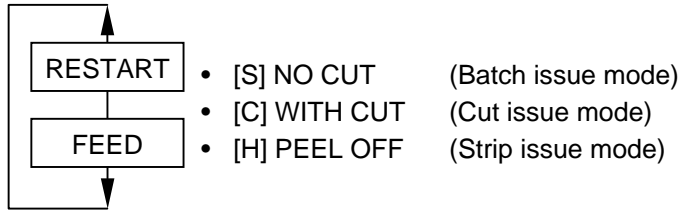

(8) Label length (LABEL LEN.)



(9) Paper feed (PAPER)

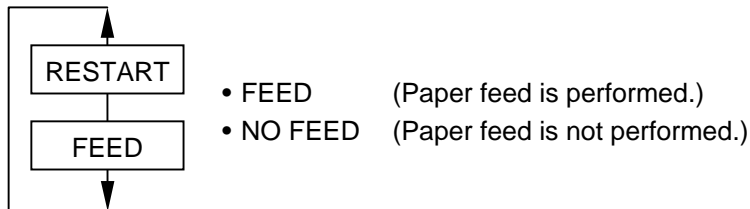

(10) Parameter values after the power is turned off and on again

- Menu selection: Test print condition parameter setting
- Issue count (ISSUE COUNT): 1
- Print speed (PRINT SPEED): 4 ips
- Sensor (SENSOR): Transmissive sensor
- Print type (PRT TYPE): Thermal transfer print mode
- Issue type (TYPE): Batch issue
- Label length (LABEL LEN.): 76 mm
- Paper feed (PAPER): Paper feed is performed.

(11) Supplementary explanations

- When the [FEED] and [RESTART] keys are pressed at the same time, the display shows the system mode menu.
- If the [RESTART] or [FEED] key is held down for 0.5 seconds or more when a parameter is being set or a menu is being selected, the printer enters repeat mode, in which the key is entered repeatedly.
- Each fine adjustment parameter is effective for test print except the X-coordinate fine adjustment.
- When an error occurs during a test print, an error message is displayed and printing stops. The error is cleared by pressing the [PAUSE] key and the display shows the system mode menu. Printing is not automatically resumed after the error is cleared.
- A selected menu or changed parameter becomes effective by pressing the [PAUSE] key and is retained until the power is turned off.
- A label length, larger than the image buffer length, is not acceptable. If the label length is larger than the image buffer length, the printer prints data (= image buffer length) then stops, or the printer stops because of an error.
- The test print for the assembly process is performed under the following conditions. Parameter values and a print density fine adjustment value are ignored.
  - Operations:
    - ① Feeds one label.
    - ② Prints 3-dot slant lines.
    - ③ Prints bar codes.
    - ④ Prints characters.
  - Issue count: 5 labels for each print operation
  - Print speed: 4 ips
  - Sensor: Reflective or transmissive sensor
  - Print type: Thermal transfer print mode
  - Issue mode: Batch issue
  - Label length: 76 mm
  - Print density fine adjustment value:  $\pm 0$
- When the transmissive sensor is selected, the gap length between labels should be 3 mm.

- Enlarged view of slant lines

1-dot slant line print (Print ratio: 16.7%)

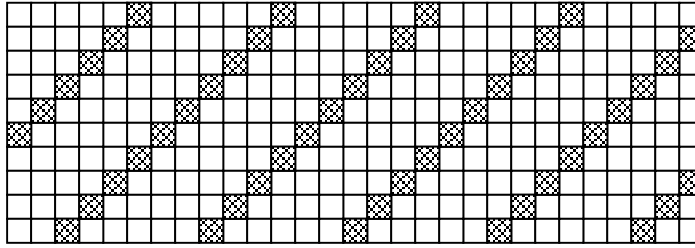

3-dot slant line print (Print ratio: 16.7%)

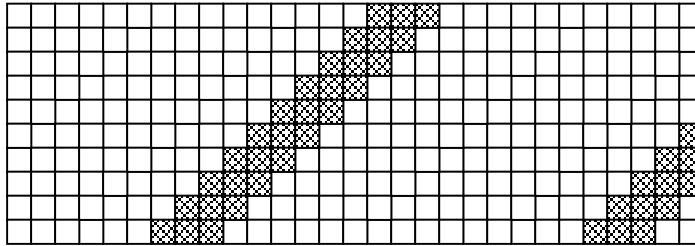

6.5.3 Test Print Samples

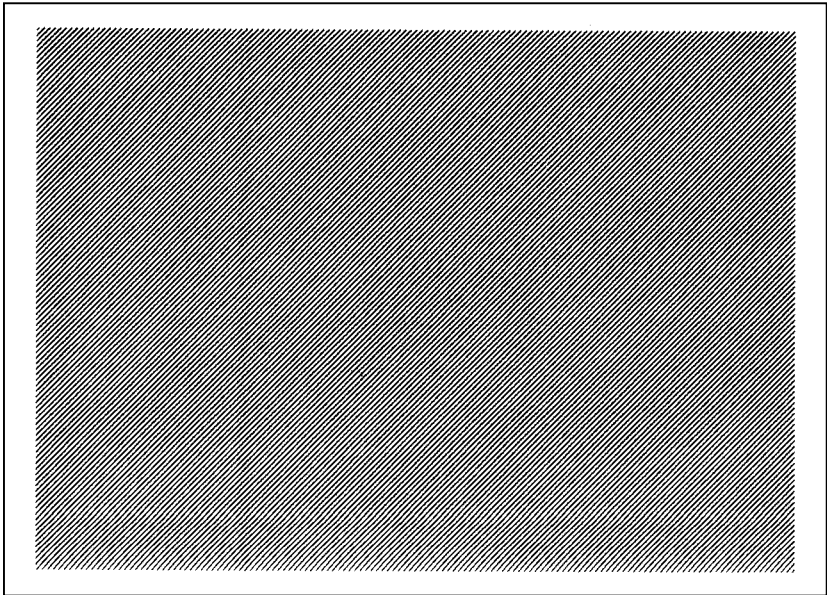

1-dot slant line print

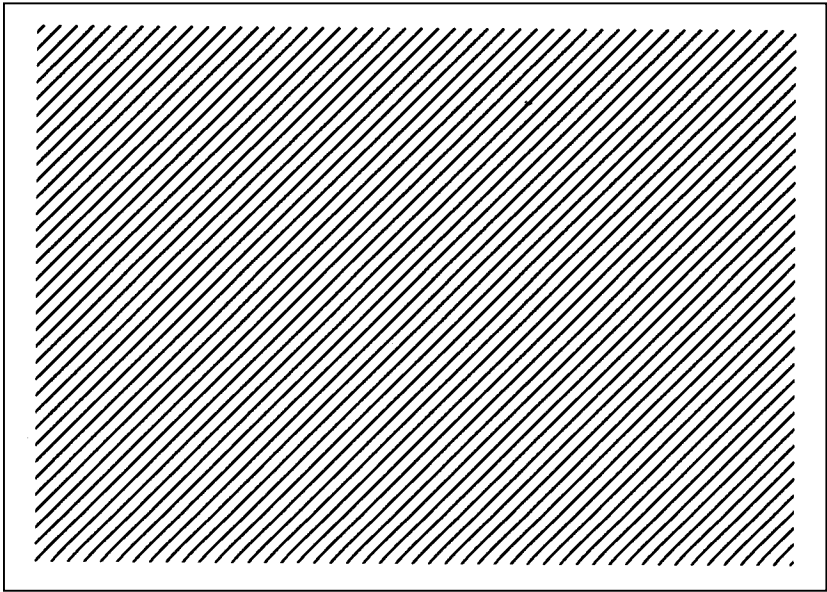

3-dot slant line print



Character print (203 dpi)



Character print (300 dpi)





Bar code print (203 dpi)



Bar code print (300 dpi)

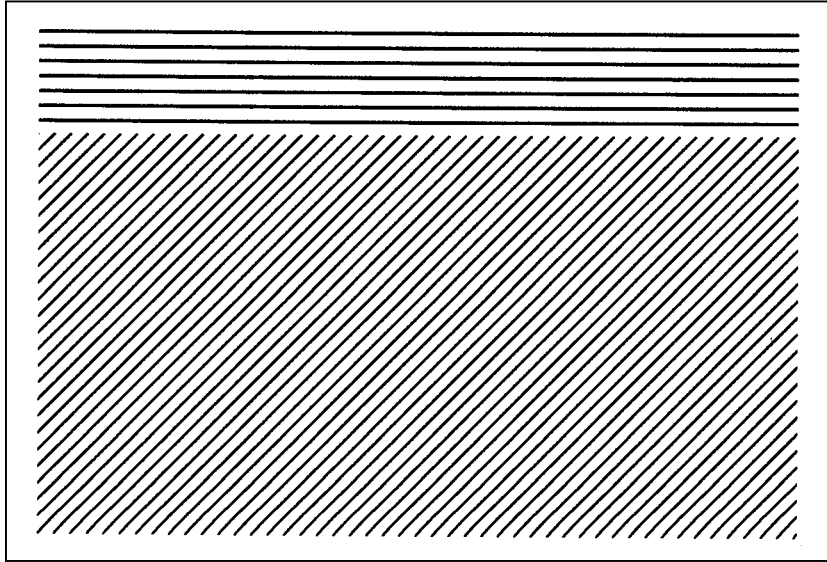

Line print for assembly process

## 6.6 SENSOR DISPLAY/ADJUSTMENT

### 6.6.1 Sensor Display/Adjustment Operation Example

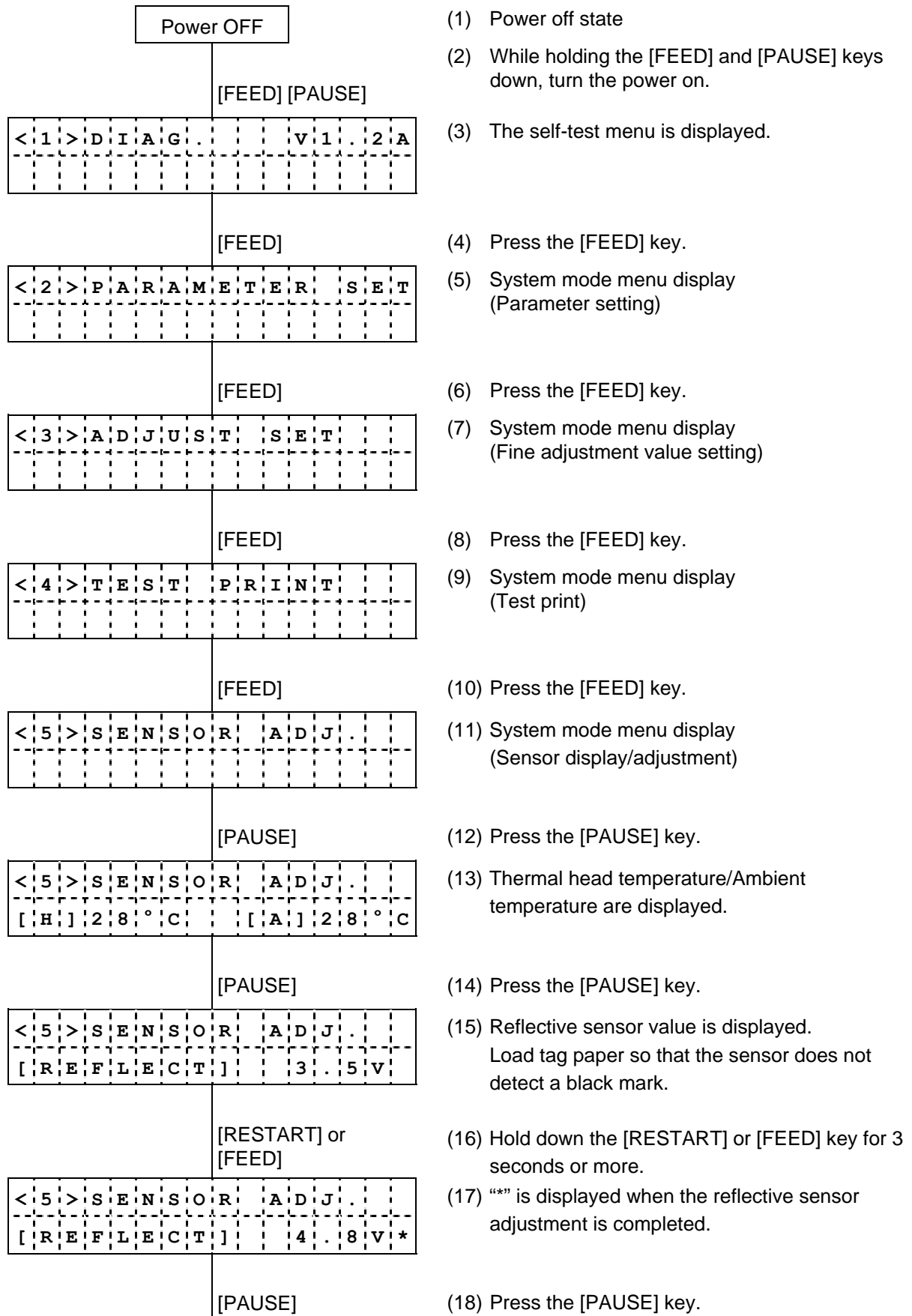

|   |   |   |   |   |   |   |   |   |   |   |   |   |   |   |   |
|---|---|---|---|---|---|---|---|---|---|---|---|---|---|---|---|
| < | 5 | > | S | E | N | S | O | R | A | D | J | . | . | . |   |
| [ | T | R | A | N | S | . | . | ] |   |   |   | 2 | . | 4 | V |

(19) Transmissive sensor value is display:  
Remove a few labels and place the backing paper so that sensor can detect backing paper.

[RESTART] or  
[FEED]

(20) Hold down the [RESTART] or [FEED] key for 3 seconds or more.

|   |   |   |   |   |   |   |   |   |   |   |   |   |   |   |   |   |
|---|---|---|---|---|---|---|---|---|---|---|---|---|---|---|---|---|
| < | 5 | > | S | E | N | S | O | R | A | D | J | . | . | . |   |   |
| [ | T | R | A | N | S | . | . | ] |   |   |   | 4 | . | 1 | V | * |

(21) "\*" is displayed when the transmissive sensor adjustment is completed.

[PAUSE]

(22) Press the [PAUSE] key.

|   |   |   |   |   |   |   |   |   |   |   |   |   |   |   |
|---|---|---|---|---|---|---|---|---|---|---|---|---|---|---|
| < | 5 | > | S | E | N | S | O | R | A | D | J | . | . | . |
| [ | P | E | ] | R | 0 | . | 1 | V | T | 4 | . | 8 | V | * |

(23) Reflective/transmissive sensor values (no paper level) are displayed.  
Remove any paper covering the sensor.

[RESTART] or  
[FEED]

(24) Hold down the [RESTART] or [FEED] key for 3 seconds or more.

|   |   |   |   |   |   |   |   |   |   |   |   |   |   |   |
|---|---|---|---|---|---|---|---|---|---|---|---|---|---|---|
| < | 5 | > | S | E | N | S | O | R | A | D | J | . | . | . |
| [ | P | E | ] | R | 0 | . | 1 | V | T | 4 | . | 8 | V | * |

(25) "\*" is displayed when the reflective/transmissive sensor adjustment (no paper level) is completed.

[PAUSE]

(26) Press the [PAUSE] key.

|   |   |   |   |   |   |   |   |   |   |   |   |   |   |   |  |  |
|---|---|---|---|---|---|---|---|---|---|---|---|---|---|---|--|--|
| < | 5 | > | S | E | N | S | O | R | A | D | J | . | . | . |  |  |
|   |   |   |   |   |   |   |   |   |   |   |   |   |   |   |  |  |

(27) System mode menu display  
(Sensor display/adjustment)

## 6.6.2 Details of Sensor Adjustment Value Display

### (1) Sensor adjustment value display

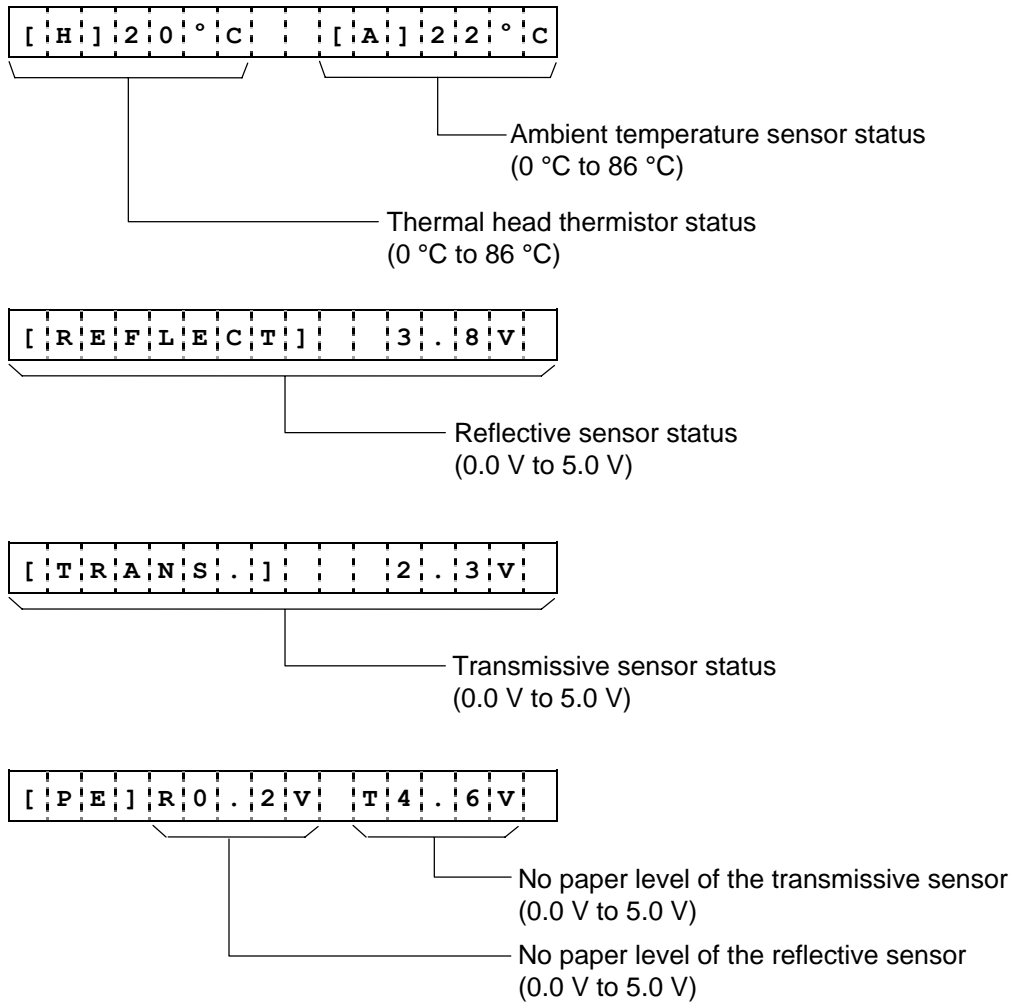

### (2) Supplementary explanations

- During a sensor check, status of each sensor is monitored and displayed every 200 msec. (The display changes in accordance with sensor status.)
- When the [FEED] and [RESTART] keys are pressed at the same time, the system mode menu is displayed.

## 6.7 RAM CLEAR

### 6.7.1 RAM Clear Operation Example

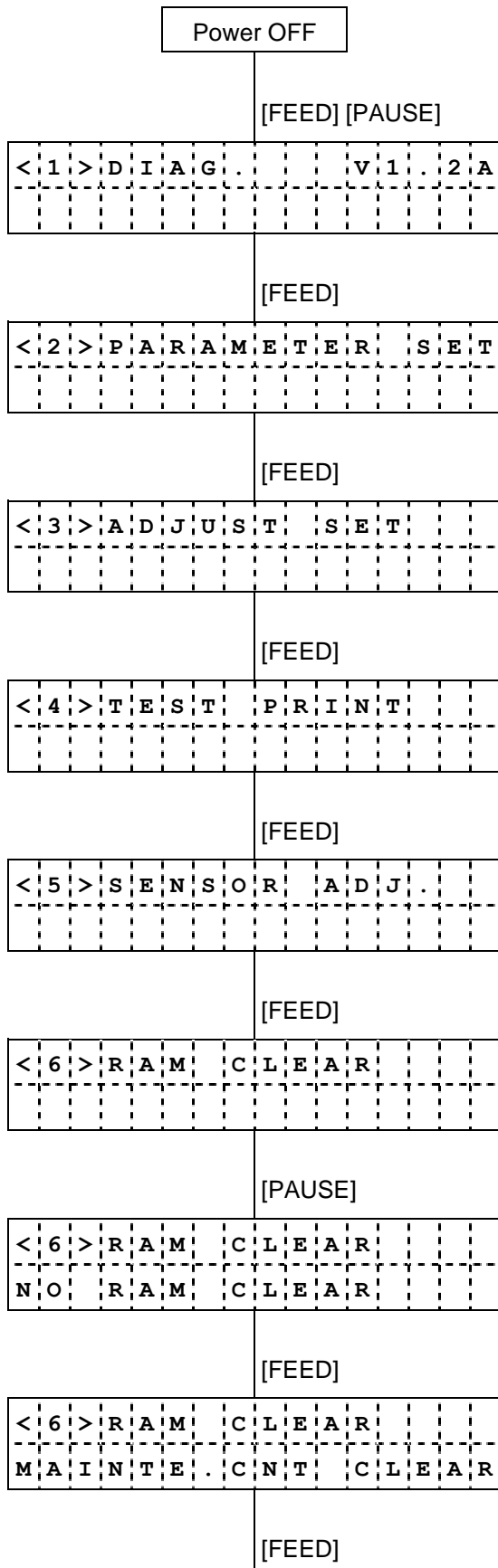

- (1) Power off state
- (2) While holding the [FEED] and [PAUSE] keys down, turn the power on.
- (3) The self-test menu is displayed.
- (4) Press the [FEED] key.
- (5) System mode menu display (Parameter setting)
- (6) Press the [FEED] key.
- (7) System mode menu display (Fine adjustment value setting)
- (8) Press the [FEED] key.
- (9) System mode menu display (Test print)
- (10) Press the [FEED] key.
- (11) System mode menu display (Sensor display/adjustment)
- (12) Press the [FEED] key.
- (13) System mode menu display (RAM clear)
- (14) Press the [PAUSE] key.
- (15) No RAM clear mode  
(\* ) A mode to prevent RAM clear from being performed mistakenly
- (16) Press the [FEED] key.
- (17) Maintenance counter clear mode
- (18) Press the [FEED] key.

|   |   |   |   |   |   |   |   |   |   |   |   |   |   |  |
|---|---|---|---|---|---|---|---|---|---|---|---|---|---|--|
| < | 6 | > | R | A | M | C | L | E | A | R |   |   |   |  |
| P | A | R | A | M | E | T | E | R | C | L | E | A | R |  |

(19) Parameter clear mode

[PAUSE]

(20) Press the [PAUSE] key.

|   |   |   |   |   |   |   |   |   |   |   |   |  |  |  |
|---|---|---|---|---|---|---|---|---|---|---|---|--|--|--|
| < | 6 | > | R | A | M | C | L | E | A | R |   |  |  |  |
| * | * | * | Q | M | T | Y | P | E | * | * | * |  |  |  |

(21) RAM clear for the QM type

[FEED]

(22) Press the [FEED] key.

|   |   |   |   |   |   |   |   |   |   |   |   |  |  |  |
|---|---|---|---|---|---|---|---|---|---|---|---|--|--|--|
| < | 6 | > | R | A | M | C | L | E | A | R |   |  |  |  |
| * | * | * | J | A | T | Y | P | E | * | * | * |  |  |  |

(23) RAM clear for the JA type

[FEED]

(24) Press the [FEED] key.

|   |   |   |   |   |   |   |   |   |   |   |  |  |  |  |
|---|---|---|---|---|---|---|---|---|---|---|--|--|--|--|
| < | 6 | > | R | A | M | C | L | E | A | R |  |  |  |  |
| * |   |   |   |   |   |   |   |   |   |   |  |  |  |  |

(25) Parameter clear is executed.

Select a type according to a destination.

|   |   |   |   |   |   |   |   |   |   |   |  |  |  |  |
|---|---|---|---|---|---|---|---|---|---|---|--|--|--|--|
| < | 6 | > | R | A | M | C | L | E | A | R |  |  |  |  |
| * | * |   |   |   |   |   |   |   |   |   |  |  |  |  |

|   |   |   |   |   |   |   |   |   |   |   |  |  |  |  |
|---|---|---|---|---|---|---|---|---|---|---|--|--|--|--|
| < | 6 | > | R | A | M | C | L | E | A | R |  |  |  |  |
| * | * | * |   |   |   |   |   |   |   |   |  |  |  |  |

(26) Progress display

|   |   |   |   |   |   |   |   |   |   |   |   |   |   |   |
|---|---|---|---|---|---|---|---|---|---|---|---|---|---|---|
| < | 6 | > | R | A | M | C | L | E | A | R |   |   |   |   |
| * | * | * | * | * | * | * | * | * | * | * | * | * | * | * |

|   |   |   |   |   |   |   |   |   |   |   |   |   |   |   |
|---|---|---|---|---|---|---|---|---|---|---|---|---|---|---|
| < | 6 | > | R | A | M | C | L | E | A | R |   |   |   |   |
| * | * | * | C | O | M | P | L | E | T | E | * | * | * | * |

(27) Parameter clear is complete.

(28) Turn the power off.

|  |  |  |  |  |  |  |  |  |  |  |  |  |  |  |
|--|--|--|--|--|--|--|--|--|--|--|--|--|--|--|
|  |  |  |  |  |  |  |  |  |  |  |  |  |  |  |
|  |  |  |  |  |  |  |  |  |  |  |  |  |  |  |

## 6.7.2 Details of RAM Clear

### (1) RAM clear mode

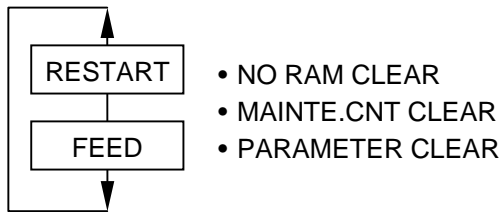

### (2) Destination type

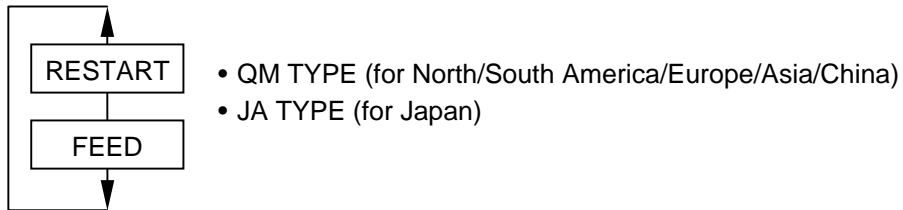

### (3) Supplementary explanations

- When the [FEED] and [RESTART] keys are pressed at the same time, the display shows the system mode menu.
- When "COMPLETE" is displayed after a RAM clear is complete, turn off the power.
- The total label distance covered, sensor adjustment values (system mode <5>), the IP address setting, socket communication port number, languages for LCD messages, and data of flash memory on the CPU are not cleared by a RAM clear.
- The number of times a tag data write succeeded and the number of times a tag data write failed are not cleared by a RAM clear.

**NOTE:** To check a destination type ([QM] or [JA]), see the upper right area of a maintenance counter printout.

### (4) Values after maintenance counter clear

| Item                               | Value   |
|------------------------------------|---------|
| Label distance covered             | 0 km    |
| Print distance                     | 0 km    |
| Cut count                          | 0       |
| Ribbon motor drive time            | 0 hours |
| RS-232C hardware error count       | 0       |
| System error count                 | 0       |
| Momentary power interruption count | 0       |



## (5) Values after parameter clear

| Parameter  |         | Value   |
|--|---------|---|
| Feed amount fine adjustment (PC)                                 |         | 0 mm  |
| Cut (strip) position fine adjustment (PC)                        |         | 0 mm  |
| Reverse feed amount fine adjustment (PC)                         |         | 0 mm  |
| Print tone fine adjustment:<br>Thermal transfer print mode (PC)  |         | 0   |
| Print tone fine adjustment:<br>Direct thermal print mode (PC)    |         | 0   |
| Ribbon motor drive voltage fine adjustment<br>(Take-up) (PC)     |         | 0   |
| Ribbon motor drive voltage fine adjustment<br>(Feed) (PC)        |         | 0   |
| Feed amount fine adjustment (Key)                                |         | 0 mm  |
| Cut (strip) position fine adjustment (Key)                       |         | 0 mm  |
| Reverse feed amount fine adjustment (Key)                        |         | 0 mm  |
| Print tone fine adjustment:<br>Thermal transfer print mode (Key) |         | 0   |
| Print tone fine adjustment:<br>Direct thermal print mode (Key)   |         | 0   |
| Ribbon motor drive voltage fine adjustment<br>(Take-up) (Key)    |         | 0   |
| Ribbon motor drive voltage fine adjustment<br>(Feed) (Key)       |         | 0   |
| X-coordinate fine adjustment (Key)                               |         | 0 mm  |
| Transmissive sensor manual threshold fine<br>adjustment value    |         | 1.4 V   |
| Reflective sensor manual threshold fine adjustment<br>value      |         | 1.0 V   |
| Character code   |         | PC-850  |
| Font "0"   |         | "0" (without slash)   |
| RS232C communication speed                                       |         | 9600 bps  |
| RS232C data length   |         | 8 bits  |
| RS232C stop bit length   |         | 1 bit   |
| RS232C parity  | QM type | NONE  |
|  | JA type | EVEN  |
| RS232C flow control method                                       |         | XON/XOFF + READY/BUSY (DTR)<br>protocol:<br>(XON output when the power is on,<br>XOFF output when the power is off) |
| Language for LCD messages  | QM type | English   |
|  | JA type | Japan   |
| Forward feed standby after an issue                              |         | OFF<br>(ON when the cutter is attached.)  |
| Control code   |         | Auto  |
| Strip wait status  |         | OFF   |
| [FEED] key function  |         | FEED (Feeds one label.)   |
| Kanji code   |         | TYPE1   |
| Euro code  |         | B0H   |
| Automatic head broken dots check                                 |         | OFF   |
| Centronics ACK/BUSY timing                                       |         | TYPE1   |

| Parameter   |         | Value                                 |
|---|---------|---------------------------------------|
| Web printer function  |         | OFF                                   |
| Reset process when the nlnit signal is ON                   |         | OFF                                   |
| Ribbon near end detection                                   |         | OFF                                   |
| Expansion I/O operation mode                                |         | Normal                                |
| Plug-and-play operation mode                                |         | OFF                                   |
| Label end/ribbon error process                              |         | The printer stops an issue operation. |
| Pre-strip process   |         | OFF                                   |
| Reverse feed speed  |         | 3 ips                                 |
| MaxiCode specification                                      |         | TYPE1                                 |
| Keyboard I/F  |         | OFF                                   |
| Automatic calibration                                       |         | OFF                                   |
| LAN enable/disable  |         | Enable                                |
| Status response   |         | ON                                    |
| Label pitch   |         | 76.2 mm                               |
| Effective print length                                      |         | 74.2 mm                               |
| Effective print width                                       | 203 dpi | 104.0 mm                              |
|   | 300 dpi | 105.7 mm                              |
| Print method  |         | Thermal transfer print mode           |
| Sensor type   |         | Transmissive sensor                   |
| Feed speed  |         | 4"/sec.                               |
| Issue mode  |         | Batch                                 |
| PC-save automatic call                                      |         | ON                                    |
| BASIC interpreter setting                                   |         | OFF                                   |
| BASIC interpreter trace setting                             |         | OFF                                   |
| DHCP setting  |         | OFF                                   |
| RFID module type selection                                  |         | NONE                                  |
| RFID tag type selection                                     |         | NONE                                  |
| RFID error tag detection                                    |         | OFF                                   |
| Max. number of issue retries                                |         | 3                                     |
| Max. number of read retries                                 |         | 5                                     |
| Read retry time-out   |         | 4.0 seconds                           |
| Max. number of write retries                                |         | 5                                     |
| Write retry time-out  |         | 2.0 seconds                           |
| RFID adjustment for retry                                   |         | OFF: +00 mm                           |
| Radio output power level                                    |         | 18                                    |
| AGC threshold   |         | 0                                     |
| RFID channel<br>(Not available to the B-SA704-RFID-U2-EU-R) |         | AUTO                                  |
| Q value   |         | 2                                     |
| AGC threshold for data write                                |         | 11                                    |
| AGC threshold lower limit for retry                         |         | 11                                    |
| The number of times tag data write succeeded                |         | 0                                     |
| The number of times tag data write failed                   |         | 0                                     |
| Strip motor torque  |         | R0                                    |
| RTC low battery check                                       |         | OFF                                   |
| RTC data renewal timing                                     |         | BATCH                                 |
| Print head applied current table setting                    |         | TYPE1                                 |

## 6.8 IP ADDRESS SETTING

### 6.8.1 IP Address Setting Operation Example

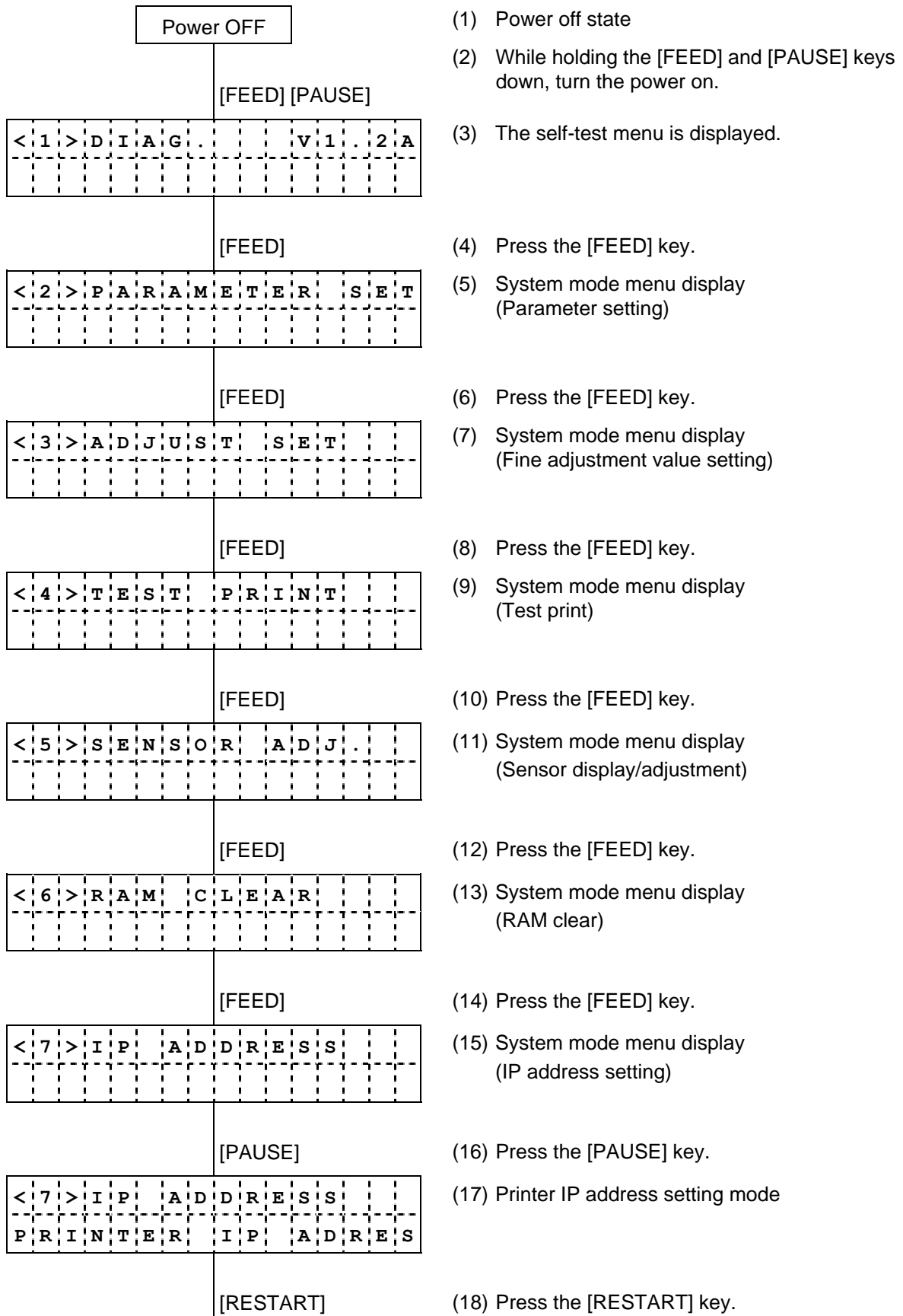

|   |   |   |   |   |   |   |   |   |   |   |   |   |   |
|---|---|---|---|---|---|---|---|---|---|---|---|---|---|
| < | 7 | > | I | P | A | D | D | R | E | S | S |   |   |
| G | A | T | E | W | A | Y | I | P | A | D | R | E | S |

(19) Gateway IP address setting mode

[RESTART]

(20) Press the [RESTART] key.

|   |   |   |   |   |   |   |   |   |   |   |   |  |
|---|---|---|---|---|---|---|---|---|---|---|---|--|
| < | 7 | > | I | P | A | D | D | R | E | S | S |  |
| S | U | B | N | E | T | M | A | S | K |   |   |  |

(21) Subnet mask setting mode

[RESTART]

(22) Press the [RESTART] key.

|   |   |   |   |   |   |   |   |   |   |   |   |  |
|---|---|---|---|---|---|---|---|---|---|---|---|--|
| < | 7 | > | I | P | A | D | D | R | E | S | S |  |
| S | O | C | K | E | T | P | O | R | T |   |   |  |

(23) Socket port number setting mode

[RESTART]

(24) Press the [RESTART] key.

|   |   |   |   |   |   |   |   |   |   |   |   |  |
|---|---|---|---|---|---|---|---|---|---|---|---|--|
| < | 7 | > | I | P | A | D | D | R | E | S | S |  |
| D | H | C | P |   |   |   |   |   |   |   |   |  |

(25) DHCP function setting mode

[PAUSE]

(26) Press the [PAUSE] key.

|   |   |   |   |   |   |   |   |   |   |   |   |  |
|---|---|---|---|---|---|---|---|---|---|---|---|--|
| < | 7 | > | I | P | A | D | D | R | E | S | S |  |
| D | H | C | P | C | L | I | E | N | T | I | D |  |

(27) DHCP client ID setting mode

[PAUSE]

(28) Press the [PAUSE] key.

|   |   |   |   |   |   |   |   |   |   |   |   |  |
|---|---|---|---|---|---|---|---|---|---|---|---|--|
| < | 7 | > | I | P | A | D | D | R | E | S | S |  |
| D | H | C | P | H | O | S | T | N | A | M | E |  |

(29) DHCP host name setting mode

[PAUSE]

(30) Press the [PAUSE] key.

|   |   |   |   |   |   |   |   |   |   |   |   |   |   |
|---|---|---|---|---|---|---|---|---|---|---|---|---|---|
| < | 7 | > | I | P | A | D | D | R | E | S | S |   |   |
| P | R | I | N | T | E | R | I | P | A | D | R | E | S |

(31) Printer IP address setting mode

[PAUSE]

(32) Press the [PAUSE] key.

|   |   |   |   |   |   |   |   |   |   |   |   |   |   |   |
|---|---|---|---|---|---|---|---|---|---|---|---|---|---|---|
| < | 7 | > | I | P | A | D | D | R | E | S | S |   |   |   |
| 1 | 9 | 2 | . | 1 | 6 | 8 | . | 0 | 1 | 0 | . | 0 | 1 | 0 |

(33) Printer IP address display

[FEED]

(34) Press the [FEED] key.

|   |   |   |   |   |   |   |   |   |   |   |   |   |   |   |
|---|---|---|---|---|---|---|---|---|---|---|---|---|---|---|
| < | 7 | > | I | P | A | D | D | R | E | S | S |   |   |   |
| 1 | 9 | 1 | . | 1 | 6 | 8 | . | 0 | 1 | 0 | . | 0 | 1 | 0 |

(35) Setting for the first 8 bits

[FEED]

(36) Press the [FEED] key.

|   |   |   |   |   |   |   |   |   |   |   |   |   |   |   |
|---|---|---|---|---|---|---|---|---|---|---|---|---|---|---|
| < | 7 | > | I | P | A | D | D | R | E | S | S |   |   |   |
| 1 | 9 | 0 | . | 1 | 6 | 8 | . | 0 | 1 | 0 | . | 0 | 1 | 0 |

(37) Setting for the first 8 bits

[FEED].....

(38) Press the [FEED] key.

|   |   |   |   |   |   |   |   |   |   |   |   |   |   |   |
|---|---|---|---|---|---|---|---|---|---|---|---|---|---|---|
| < | 7 | > | I | P | A | D | D | R | E | S | S |   |   |   |
| 1 | 5 | 7 | . | 1 | 6 | 8 | . | 0 | 1 | 0 | . | 0 | 1 | 0 |

(39) Setting for the first 8 bits

[PAUSE]

(40) Press the [PAUSE] key.

|   |   |   |   |   |   |   |   |   |   |   |   |   |   |   |
|---|---|---|---|---|---|---|---|---|---|---|---|---|---|---|
| < | 7 | > | I | P | A | D | D | R | E | S | S |   |   |   |
| 1 | 5 | 7 | . | 1 | 6 | 7 | . | 0 | 1 | 0 | . | 0 | 1 | 0 |

(41) The first 8 bits are entered and the setting goes on to the next 8 bits.

[FEED]

(42) Press the [FEED] key.

|   |   |   |   |   |   |   |   |   |   |   |   |   |   |   |
|---|---|---|---|---|---|---|---|---|---|---|---|---|---|---|
| < | 7 | > | I | P | A | D | D | R | E | S | S |   |   |   |
| 1 | 5 | 7 | . | 1 | 6 | 7 | . | 0 | 1 | 0 | . | 0 | 1 | 0 |

(43) Setting for the next 8 bits

[FEED]

(44) Press the [FEED] key.

|   |   |   |   |   |   |   |   |   |   |   |   |   |   |   |
|---|---|---|---|---|---|---|---|---|---|---|---|---|---|---|
| < | 7 | > | I | P | A | D | D | R | E | S | S |   |   |   |
| 1 | 5 | 7 | . | 1 | 6 | 6 | . | 0 | 1 | 0 | . | 0 | 1 | 0 |

(45) Setting for the next 8 bits

[PAUSE]

(46) Press the [PAUSE] key.

|   |   |   |   |   |   |   |   |   |   |   |   |   |   |   |
|---|---|---|---|---|---|---|---|---|---|---|---|---|---|---|
| < | 7 | > | I | P | A | D | D | R | E | S | S |   |   |   |
| 1 | 5 | 7 | . | 1 | 6 | 5 | . | 0 | 1 | 0 | . | 0 | 1 | 0 |

(47) Setting for the next 8 bits

[FEED].....

(48) Press the [FEED] key.

|   |   |   |   |   |   |   |   |   |   |   |   |   |   |   |
|---|---|---|---|---|---|---|---|---|---|---|---|---|---|---|
| < | 7 | > | I | P | A | D | D | R | E | S | S |   |   |   |
| 1 | 5 | 7 | . | 0 | 6 | 9 | . | 0 | 1 | 0 | . | 0 | 1 | 0 |

(49) Setting for the next 8 bits

[PAUSE]

(50) Press the [PAUSE] key.

|   |   |   |   |   |   |   |   |   |   |   |   |   |   |   |
|---|---|---|---|---|---|---|---|---|---|---|---|---|---|---|
| < | 7 | > | I | P | A | D | D | R | E | S | S |   |   |   |
| 1 | 5 | 7 | . | 0 | 6 | 9 | . | 0 | 1 | 0 | . | 0 | 1 | 0 |

(51) The 8 bits are entered and the setting goes on to the next 8 bits.

[RESTART]

(52) Press the [RESTART] key.

|   |   |   |   |   |   |   |   |   |   |   |   |   |   |   |
|---|---|---|---|---|---|---|---|---|---|---|---|---|---|---|
| < | 7 | > | I | P | A | D | D | R | E | S | S |   |   |   |
| 1 | 5 | 7 | . | 0 | 6 | 9 | . | 0 | 1 | 1 | . | 0 | 1 | 0 |

(53) Setting for the next 8 bits

[RESTART]

(54) Press the [RESTART] key.

|   |   |   |   |   |   |   |   |   |   |   |   |   |   |   |
|---|---|---|---|---|---|---|---|---|---|---|---|---|---|---|
| < | 7 | > | I | P | A | D | D | R | E | S | S |   |   |   |
| 1 | 5 | 7 | . | 0 | 6 | 9 | . | 0 | 1 | 2 | . | 0 | 1 | 0 |

(55) Setting for the next 8 bits

[RESTART]

|   |   |   |   |   |   |   |   |   |   |   |   |   |   |   |
|---|---|---|---|---|---|---|---|---|---|---|---|---|---|---|
| < | 7 | > | I | P | A | D | D | R | E | S | S |   |   |   |
| 1 | 5 | 7 | . | 0 | 6 | 9 | . | 0 | 1 | 3 | . | 0 | 1 | 0 |

(56) Press the [RESTART] key.

(57) Setting for the next 8 bits

[RESTART].....

|   |   |   |   |   |   |   |   |   |   |   |   |   |   |   |
|---|---|---|---|---|---|---|---|---|---|---|---|---|---|---|
| < | 7 | > | I | P | A | D | D | R | E | S | S |   |   |   |
| 1 | 5 | 7 | . | 0 | 6 | 9 | . | 0 | 4 | 6 | . | 0 | 1 | 0 |

(58) Press the [RESTART] key.

(59) Setting for the next 8 bits

[PAUSE]

|   |   |   |   |   |   |   |   |   |   |   |   |   |   |   |
|---|---|---|---|---|---|---|---|---|---|---|---|---|---|---|
| < | 7 | > | I | P | A | D | D | R | E | S | S |   |   |   |
| 1 | 5 | 7 | . | 0 | 6 | 9 | . | 0 | 4 | 6 | . | 0 | 1 | 0 |

(60) Press the [PAUSE] key.

(61) The 8 bits are entered and the setting goes on to the next 8 bits.

[RESTART]

|   |   |   |   |   |   |   |   |   |   |   |   |   |   |   |
|---|---|---|---|---|---|---|---|---|---|---|---|---|---|---|
| < | 7 | > | I | P | A | D | D | R | E | S | S |   |   |   |
| 1 | 5 | 7 | . | 0 | 6 | 9 | . | 0 | 4 | 6 | . | 0 | 1 | 1 |

(62) Press the [RESTART] key.

(63) Setting for the next 8 bits

[RESTART]

|   |   |   |   |   |   |   |   |   |   |   |   |   |   |   |
|---|---|---|---|---|---|---|---|---|---|---|---|---|---|---|
| < | 7 | > | I | P | A | D | D | R | E | S | S |   |   |   |
| 1 | 5 | 7 | . | 0 | 6 | 9 | . | 0 | 4 | 6 | . | 0 | 1 | 2 |

(64) Press the [RESTART] key.

(65) Setting for the next 8 bits

[RESTART]

|   |   |   |   |   |   |   |   |   |   |   |   |   |   |   |
|---|---|---|---|---|---|---|---|---|---|---|---|---|---|---|
| < | 7 | > | I | P | A | D | D | R | E | S | S |   |   |   |
| 1 | 5 | 7 | . | 0 | 6 | 9 | . | 0 | 4 | 6 | . | 0 | 1 | 3 |

(66) Press the [RESTART] key.

(67) Setting for the next 8 bits

[RESTART].....

|   |   |   |   |   |   |   |   |   |   |   |   |   |   |   |
|---|---|---|---|---|---|---|---|---|---|---|---|---|---|---|
| < | 7 | > | I | P | A | D | D | R | E | S | S |   |   |   |
| 1 | 5 | 7 | . | 0 | 6 | 9 | . | 0 | 4 | 6 | . | 1 | 2 | 4 |

(68) Press the [RESTART] key.

(69) Setting for the next 8 bits

[PAUSE]

|   |   |   |   |   |   |   |   |   |   |   |   |   |   |
|---|---|---|---|---|---|---|---|---|---|---|---|---|---|
| < | 7 | > | I | P | A | D | D | R | E | S | S |   |   |
| G | A | T | E | W | A | Y | I | P | A | D | R | E | S |

(70) Press the [PAUSE] key.

(71) Gateway IP address setting mode

[PAUSE]

|   |   |   |   |   |   |   |   |   |   |   |   |   |   |   |
|---|---|---|---|---|---|---|---|---|---|---|---|---|---|---|
| < | 7 | > | I | P | A | D | D | R | E | S | S |   |   |   |
| 0 | 0 | 0 | . | 0 | 0 | 0 | . | 0 | 0 | 0 | . | 0 | 0 | 0 |

(72) Press the [PAUSE] key.

(73) Gateway IP address display

(74) Gateway IP address setting

|   |   |   |   |   |   |   |   |   |   |   |   |  |  |
|---|---|---|---|---|---|---|---|---|---|---|---|--|--|
| < | 7 | > | I | P | A | D | D | R | E | S | S |  |  |
| S | U | B | N | E | T | M | A | S | K |   |   |  |  |

(75) Subnet mask setting mode

[PAUSE]

(76) Press the [PAUSE] key.

|   |   |   |   |   |   |   |   |   |   |   |   |   |   |   |
|---|---|---|---|---|---|---|---|---|---|---|---|---|---|---|
| < | 7 | > | I | P | A | D | D | R | E | S | S |   |   |   |
| 2 | 5 | 5 | . | 2 | 5 | 5 | . | 2 | 5 | 5 | . | 0 | 0 | 0 |

(77) Subnet mask display

(78) Subnet mask setting

|   |   |   |   |   |   |   |   |   |   |   |   |  |  |
|---|---|---|---|---|---|---|---|---|---|---|---|--|--|
| < | 7 | > | I | P | A | D | D | R | E | S | S |  |  |
| S | O | C | K | E | T | P | O | R | T |   |   |  |  |

(79) Socket communication port setting mode

[PAUSE]

(80) Press the [PAUSE] key.

|   |   |   |   |   |   |   |   |   |   |   |   |  |  |
|---|---|---|---|---|---|---|---|---|---|---|---|--|--|
| < | 7 | > | I | P | A | D | D | R | E | S | S |  |  |
| P | O | R | T | O | F | F | - | - | - | - | - |  |  |

(81) Socket communication setting (Disabled)

[RESTART]

(82) Press the [RESTART] key.

|   |   |   |   |   |   |   |   |   |   |   |   |   |   |
|---|---|---|---|---|---|---|---|---|---|---|---|---|---|
| < | 7 | > | I | P | A | D | D | R | E | S | S |   |   |
| P | O | R | T | O | N |   |   | 0 | 8 | 0 | 0 | 0 | 0 |

(83) Socket communication setting (Enabled)

[PAUSE]

(84) Press the [PAUSE] key.

|   |   |   |   |   |   |   |   |   |   |   |   |   |   |
|---|---|---|---|---|---|---|---|---|---|---|---|---|---|
| < | 7 | > | I | P | A | D | D | R | E | S | S |   |   |
| P | O | R | T | O | N |   |   | 0 | 8 | 0 | 0 | 0 | 0 |

(85) Set a value for the 5th digit.

[RESTART]

(86) Press the [RESTART] key.

|   |   |   |   |   |   |   |   |   |   |   |   |   |   |
|---|---|---|---|---|---|---|---|---|---|---|---|---|---|
| < | 7 | > | I | P | A | D | D | R | E | S | S |   |   |
| P | O | R | T | O | N |   |   | 1 | 8 | 0 | 0 | 0 | 0 |

(87) Confirm a set value for the 5th digit.

[PAUSE]

(88) Press the [PAUSE] key.

|   |   |   |   |   |   |   |   |   |   |   |   |   |   |
|---|---|---|---|---|---|---|---|---|---|---|---|---|---|
| < | 7 | > | I | P | A | D | D | R | E | S | S |   |   |
| P | O | R | T | O | N |   |   | 1 | 8 | 0 | 0 | 0 | 0 |

(89) Set a value for the 4th digit.

[FEED]

(90) Press the [FEED] key.

|   |   |   |   |   |   |   |   |   |   |   |   |   |   |
|---|---|---|---|---|---|---|---|---|---|---|---|---|---|
| < | 7 | > | I | P | A | D | D | R | E | S | S |   |   |
| P | O | R | T | O | N |   |   | 1 | 7 | 0 | 0 | 0 | 0 |

(91) Confirm a set value for the 4th digit.

[PAUSE]

(92) Press the [PAUSE] key.

|   |   |   |   |   |   |   |   |   |   |   |   |   |
|---|---|---|---|---|---|---|---|---|---|---|---|---|
| < | 7 | > | I | P | A | D | D | R | E | S | S |   |
| P | O | R | T | O | N |   |   |   | 1 | 7 | 0 | 0 |

(93) Enter values for the 3rd to the 1st digits.

[FEED].....  
 [RESTART].....  
 [PAUSE].....

(94) Set values for the 3rd to the 1st digits.

|   |   |   |   |   |   |   |   |   |   |   |   |  |
|---|---|---|---|---|---|---|---|---|---|---|---|--|
| < | 7 | > | I | P | A | D | D | R | E | S | S |  |
| D | H | C | P |   |   |   |   |   |   |   |   |  |

(95) DHCP setting

[PAUSE]

(96) Press the [PAUSE] key.

|   |   |   |   |   |   |   |   |   |   |   |   |  |
|---|---|---|---|---|---|---|---|---|---|---|---|--|
| < | 7 | > | I | P | A | D | D | R | E | S | S |  |
| D | H | C | P |   |   |   |   |   | O | F | F |  |

(97) DHCP setting (Disabled)

[RESTART]

(98) Press the [RESTART] key.

|   |   |   |   |   |   |   |   |   |   |   |   |  |
|---|---|---|---|---|---|---|---|---|---|---|---|--|
| < | 7 | > | I | P | A | D | D | R | E | S | S |  |
| D | H | C | P |   |   |   |   |   | O | N |   |  |

(99) DHCP setting (Enabled)

[PAUSE]

(100) Press the [PAUSE] key.

|   |   |   |   |   |   |   |   |   |   |   |   |  |
|---|---|---|---|---|---|---|---|---|---|---|---|--|
| < | 7 | > | I | P | A | D | D | R | E | S | S |  |
| D | H | C | P | C | L | I | E | N | T | I | D |  |

(101) DHCP client ID setting

[PAUSE]

(102) Press the [PAUSE] key.

|   |   |   |   |   |   |   |   |   |   |   |   |   |
|---|---|---|---|---|---|---|---|---|---|---|---|---|
| M | O | D | E |   |   |   |   | A | S | C | I | I |
| D | H | C | P | C | L | I | E | N | T | I | D |   |

(103) DHCP client ID input mode setting (ASCII)\*

[RESTART]

(104) Press the [RESTART] key.

|   |   |   |   |   |   |   |   |   |   |   |   |  |
|---|---|---|---|---|---|---|---|---|---|---|---|--|
| M | O | D | E |   |   |   |   | H | E | X |   |  |
| D | H | C | P | C | L | I | E | N | T | I | D |  |

(105) DHCP client ID input mode setting (HEX)

[PAUSE]

(106) Press the [PAUSE] key.

|   |   |   |   |   |   |   |   |   |   |   |   |   |
|---|---|---|---|---|---|---|---|---|---|---|---|---|
| F | F | F | F | F | F | F | F | F | F | F | F | F |
| F | F | F | F | F | F | F | F | F | F | F | F | F |

(107) Input the DHCP client ID. (HEX)

[RESTART]

(108) Press the [RESTART] key.

|   |   |   |   |   |   |   |   |   |   |   |   |   |
|---|---|---|---|---|---|---|---|---|---|---|---|---|
| 0 | 0 | F | F | F | F | F | F | F | F | F | F | F |
| F | F | F | F | F | F | F | F | F | F | F | F | F |

(109) Input the DHCP client ID. (HEX: 1st byte)

[RESTART]

(110) Press the [RESTART] key.



|   |  |
|---|--|
| 0 1 F F F F F F F F F F F F F F F F                                     | (111) Input the DHCP client ID.<br>(HEX: 1st byte)           |
| [PAUSE]   | (112) Press the [PAUSE] key.                                 |
| 0 1 F F F F F F F F F F F F F F F F                                     | (113) Input the DHCP client ID.<br>(HEX: 2nd byte)           |
| [FEED]  | (114) Press the [FEED] key.                                  |
| 0 1 F E F F F F F F F F F F F F F F                                     | (115) Input the DHCP client ID.<br>(HEX: 2nd byte)           |
| [FEED]  | (116) Press the [FEED] key.                                  |
| 0 1 F D F F F F F F F F F F F F F F                                     | (117) Input the DHCP client ID.<br>(HEX: 2nd byte)           |
| [FEED].....<br>[RESTART].....<br>[PAUSE].....                           | (118) Input the DHCP client ID.<br>(HEX: 2nd to 16 th bytes) |
| M O D E                    A S C I I<br>D H C P   H O S T   N A M E     | (119) Input the DHCP host name.                              |
| [PAUSE]   | (120) Press the [PAUSE] key.                                 |
| M O D E                    A S C I I<br>■ ■ ■ ■ ■ ■ ■ ■ ■ ■ ■ ■ ■ ■ ■ ■ | (121) DHCP HOST NAME input mode setting<br>(ASCII) *         |
| [FEED].....<br>[RESTART].....<br>[PAUSE].....                           | (122) Press the [RESTART] key.                               |
| < 7 > I P   A D D R E S S   | (123) End of IP address setting                              |

**NOTE:** When the input mode for DHCP client ID and DHCP HOST NAME is ASCII, each byte of data is an ASCII character. Termination is FHH. It is "FF" in HEX mode and "■" before the space in ASCII mode.

### 6.8.2 IP Address Setting Operation Flow

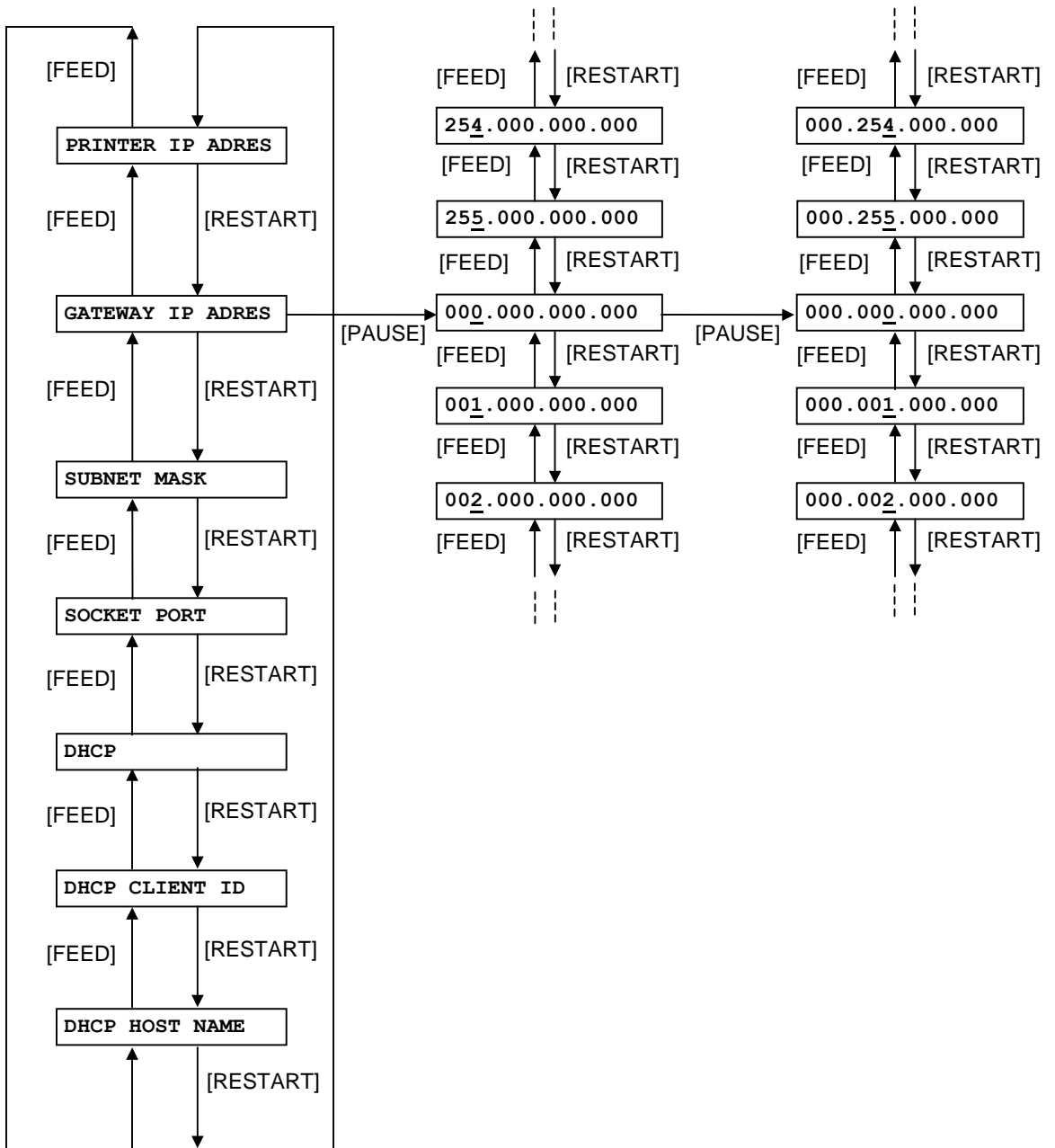

## 6.9 BASIC SETTING

### 6.9.1 BASIC Setting Operation Example

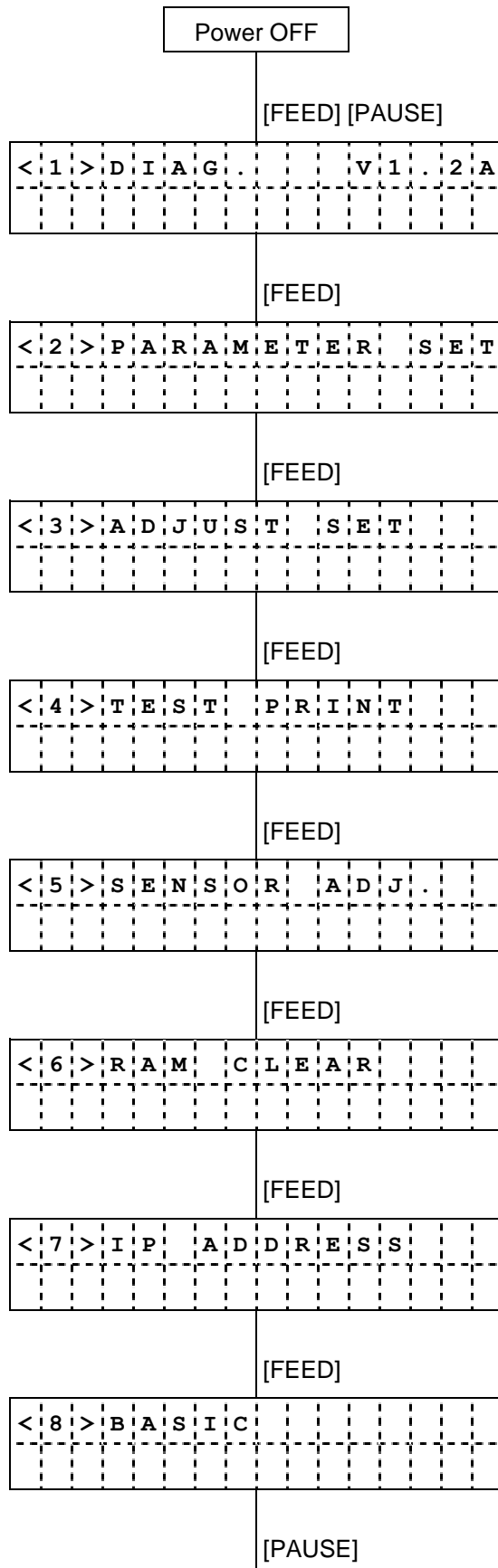

- (1) Power off state
- (2) While holding the [FEED] and [PAUSE] keys down, turn the power on.
- (3) The self-test menu is displayed.
- (4) Press the [FEED] key.
- (5) System mode menu display (Parameter setting)
- (6) Press the [FEED] key.
- (7) System mode menu display (Fine adjustment value setting)
- (8) Press the [FEED] key.
- (9) System mode menu display (Test print)
- (10) Press the [FEED] key.
- (11) System mode menu display (Sensor display/adjustment)
- (12) Press the [FEED] key.
- (13) System mode menu display (RAM clear)
- (14) Press the [FEED] key.
- (15) System mode menu display (IP address setting)
- (16) Press the [FEED] key.
- (17) BASIC setting mode
- (18) Press the [PAUSE] key.

```
< 8 > B A S I C
B A S I C E N A B L E
```

(19) BASIC enable setting mode

[RESTART]

(20) Press the [RESTART] key.

```
< 8 > B A S I C
F I L E M A I N T E N A N C E
```

(21) BASIC file browser

[RESTART]

(22) Press the [RESTART] key.

```
< 8 > B A S I C
B A S I C T R A C E
```

(23) BASIC trace setting

[RESTART]

(24) Press the [RESTART] key.

```
< 8 > B A S I C
E X P A N D M O D E
```

(25) BASIC expansion mode

[RESTART]

(26) Press the [RESTART] key.

```
< 8 > B A S I C
B A S I C E N A B L E
```

(27) BASIC enable setting mode

[PAUSE]

(28) Press the [PAUSE] key.

```
< 8 > B A S I C
B A S I C O F F
```

(29) BASIC is disabled.

[FEED]

(30) Press the [FEED] key.

```
< 8 > B A S I C
B A S I C O N
```

(31) BASIC is enabled.

[PAUSE]

(32) Press the [PAUSE] key.

```
< 8 > B A S I C
F I L E M A I N T E N A N C E
```

(33) BASIC file browser

[PAUSE]

(34) Press the [PAUSE] key.

```
< 8 > B A S I C
0 0 T E S T . B A S
```

(35) Program file display

[RESTART]

(36) Press the [RESTART] key.

|   |   |   |   |   |   |   |   |   |   |   |  |  |  |  |  |  |  |  |  |
|---|---|---|---|---|---|---|---|---|---|---|--|--|--|--|--|--|--|--|--|
| < | 8 | > | B | A | S | I | C |   |   |   |  |  |  |  |  |  |  |  |  |
| 0 | 1 |   | T | E | S | T | . | D | A | T |  |  |  |  |  |  |  |  |  |

(37) Data file display

(38) Names of data files, saved in the BASIC file area, are displayed.

|   |   |   |   |   |   |   |   |   |   |   |  |  |  |  |  |  |  |  |  |
|---|---|---|---|---|---|---|---|---|---|---|--|--|--|--|--|--|--|--|--|
| < | 8 | > | B | A | S | I | C |   |   |   |  |  |  |  |  |  |  |  |  |
| 0 | 0 |   | T | E | S | T | . | B | A | S |  |  |  |  |  |  |  |  |  |

(39) Program file display

[PAUSE]

(40) Press the [PAUSE] key.

|   |   |   |   |   |   |   |   |   |   |   |  |  |  |  |  |  |  |  |  |
|---|---|---|---|---|---|---|---|---|---|---|--|--|--|--|--|--|--|--|--|
| < | 8 | > | B | A | S | I | C |   |   |   |  |  |  |  |  |  |  |  |  |
| B | A | S | I | C |   | T | R | A | C | E |  |  |  |  |  |  |  |  |  |

(41) BASIC trace setting

[PAUSE]

(42) Press the [PAUSE] key.

|   |   |   |   |   |   |   |   |  |  |   |   |   |  |  |  |  |  |  |  |
|---|---|---|---|---|---|---|---|--|--|---|---|---|--|--|--|--|--|--|--|
| < | 8 | > | B | A | S | I | C |  |  |   |   |   |  |  |  |  |  |  |  |
| T | R | A | C | E |   |   |   |  |  | O | F | F |  |  |  |  |  |  |  |

(43) BASIC trace setting (Disabled)

[FEED]

(44) Press the [FEED] key.

|   |   |   |   |   |   |   |   |  |  |   |   |  |  |  |  |  |  |  |  |
|---|---|---|---|---|---|---|---|--|--|---|---|--|--|--|--|--|--|--|--|
| < | 8 | > | B | A | S | I | C |  |  |   |   |  |  |  |  |  |  |  |  |
| T | R | A | C | E |   |   |   |  |  | O | N |  |  |  |  |  |  |  |  |

(45) BASIC trace setting (Enabled)

[PAUSE]

(46) Press the [PAUSE] key.

|   |   |   |   |   |   |   |   |   |   |   |  |  |  |  |  |  |  |  |  |
|---|---|---|---|---|---|---|---|---|---|---|--|--|--|--|--|--|--|--|--|
| < | 8 | > | B | A | S | I | C |   |   |   |  |  |  |  |  |  |  |  |  |
| E | X | P | A | N | D | . | M | O | D | E |  |  |  |  |  |  |  |  |  |

(47) BASIC expansion mode

[PAUSE]

(48) Press the [PAUSE] key to execute the BASIC expansion mode program, if it has been loaded.

The basic expansion mode ends when the basic expansion program is exited.

|   |   |   |   |   |   |   |   |  |  |  |  |  |  |  |  |  |  |  |  |
|---|---|---|---|---|---|---|---|--|--|--|--|--|--|--|--|--|--|--|--|
| < | 8 | > | B | A | S | I | C |  |  |  |  |  |  |  |  |  |  |  |  |
|   |   |   |   |   |   |   |   |  |  |  |  |  |  |  |  |  |  |  |  |

(49) BASIC setting mode

## 6.10 ADJUSTMENT MODE FOR FACTORY

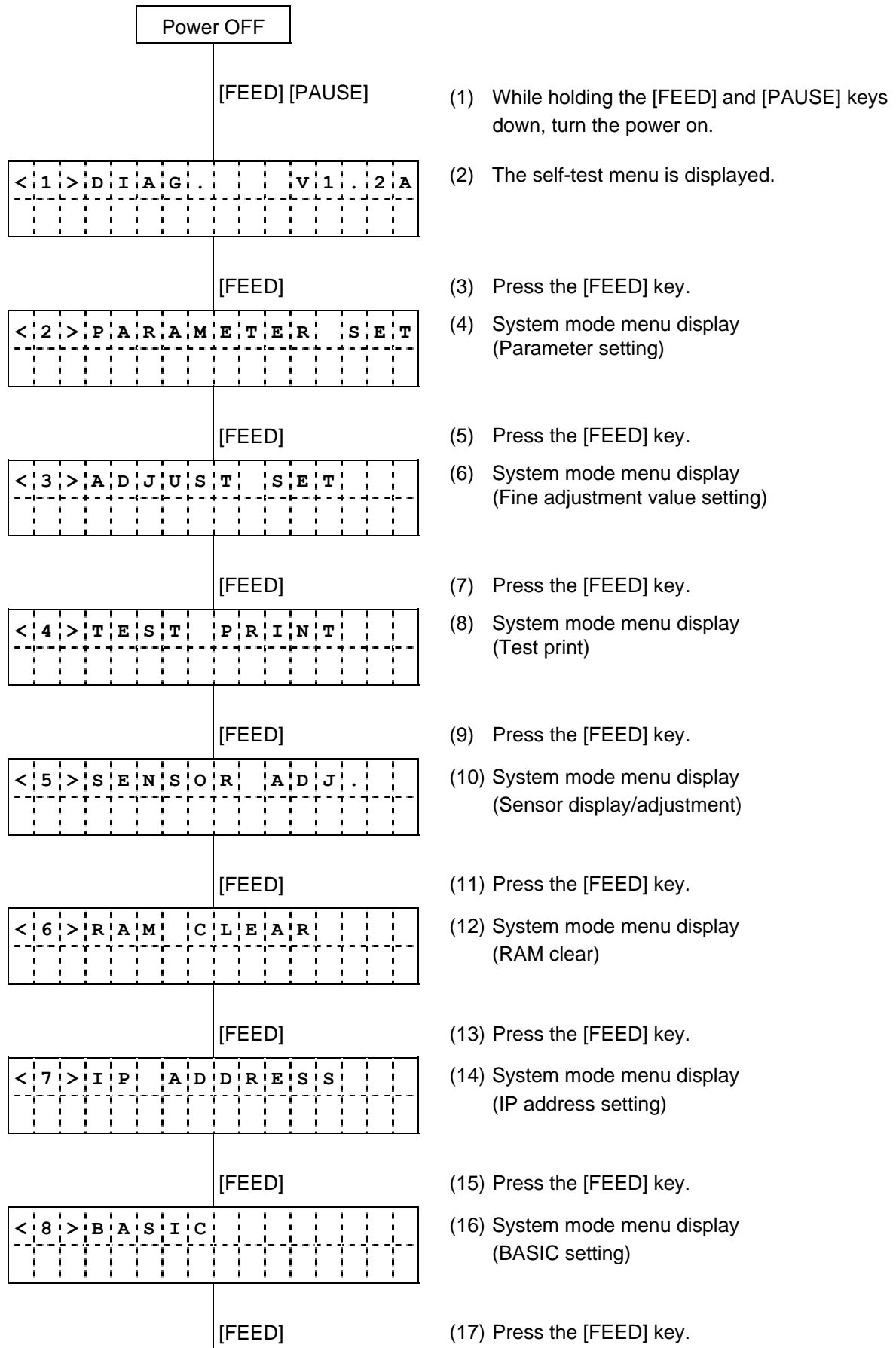

|   |   |   |   |   |   |   |   |   |   |   |   |   |
|---|---|---|---|---|---|---|---|---|---|---|---|---|
| < | 9 | > | F | O | R | F | A | C | T | O | R | Y |
|   |   |   |   |   |   |   |   |   |   |   |   |   |

(18) The menu for the adjustment mode for the factory is displayed.

[PAUSE]

(19) Press the [PAUSE] key.

|   |   |   |   |   |   |   |   |   |   |   |   |   |
|---|---|---|---|---|---|---|---|---|---|---|---|---|
| < | 9 | > | F | O | R | F | A | C | T | O | R | Y |
| O | P | T | I | O | N | C | H | E | C | K |   |   |

(20) Option check mode display

[PAUSE]

(21) Press the [PAUSE] key.

|   |   |   |   |   |   |   |   |   |   |   |   |   |   |
|---|---|---|---|---|---|---|---|---|---|---|---|---|---|
| < | 9 | > | F | O | R | F | A | C | T | O | R | Y |   |
| O | P | T | I | O | N | C | H | E | C | K |   | O | K |

(22) Option check result display

[PAUSE]

(23) Press the [PAUSE] key.

|   |   |   |   |   |   |   |   |   |   |   |   |   |
|---|---|---|---|---|---|---|---|---|---|---|---|---|
| < | 9 | > | F | O | R | F | A | C | T | O | R | Y |
|   |   |   |   |   |   |   |   |   |   |   |   |   |

(24) The display is returned to the menu for the adjustment for the factory.

**NOTE:** *Option Check*

Currently no option checks are performed and fixed to OK.

## 6.11 RFID SETTING

### 6.11.1 RFID Setting Operation Example

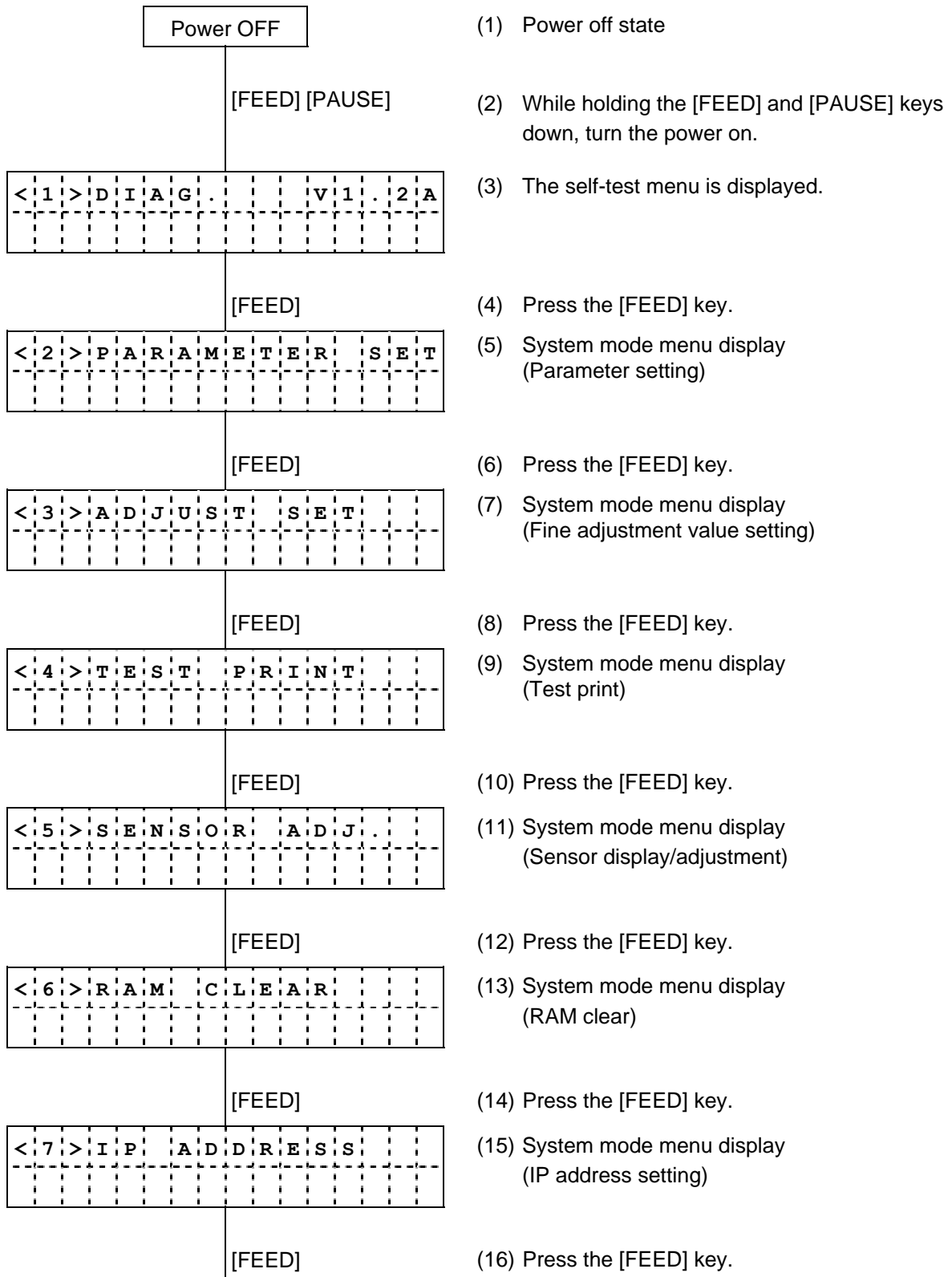



|       |   |   |   |   |   |  |  |  |  |  |  |  |  |  |  |  |  |  |  |  |  |
|-------|---|---|---|---|---|--|--|--|--|--|--|--|--|--|--|--|--|--|--|--|--|
| < 8 > | B | A | S | I | C |  |  |  |  |  |  |  |  |  |  |  |  |  |  |  |  |
|       |   |   |   |   |   |  |  |  |  |  |  |  |  |  |  |  |  |  |  |  |  |

(17) System mode menu display  
(BASIC setting)

[FEED]

(18) Press the [FEED] key.

|       |   |   |   |   |   |   |   |   |   |   |  |  |  |  |  |  |  |  |  |  |  |
|-------|---|---|---|---|---|---|---|---|---|---|--|--|--|--|--|--|--|--|--|--|--|
| < 9 > | F | O | R | F | A | C | T | O | R | Y |  |  |  |  |  |  |  |  |  |  |  |
|       |   |   |   |   |   |   |   |   |   |   |  |  |  |  |  |  |  |  |  |  |  |

(19) The menu for the adjustment mode for the factory is displayed.

[FEED]

(20) Press the [FEED] key.

|         |   |   |   |   |  |  |  |  |  |  |  |  |  |  |  |  |  |  |  |  |  |
|---------|---|---|---|---|--|--|--|--|--|--|--|--|--|--|--|--|--|--|--|--|--|
| < 1 0 > | R | F | I | D |  |  |  |  |  |  |  |  |  |  |  |  |  |  |  |  |  |
|         |   |   |   |   |  |  |  |  |  |  |  |  |  |  |  |  |  |  |  |  |  |

(21) RFID setting menu display

[PAUSE]

(22) Press the [PAUSE] key.

|         |   |   |   |   |   |   |   |  |  |  |  |  |  |  |  |  |  |  |  |   |   |   |
|---------|---|---|---|---|---|---|---|--|--|--|--|--|--|--|--|--|--|--|--|---|---|---|
| < 1 0 > | R | F | I | D |   |   |   |  |  |  |  |  |  |  |  |  |  |  |  |   |   |   |
| R       | E | A | D | T | E | S | T |  |  |  |  |  |  |  |  |  |  |  |  | O | F | F |

(23) RFID read test menu  
Enable/Disable the read test by using the [FEED] or [RESTART] key.

[PAUSE]

(24) Press the [PAUSE] key.

|         |   |   |   |   |   |   |   |   |   |   |  |  |  |  |  |  |  |  |  |   |   |   |
|---------|---|---|---|---|---|---|---|---|---|---|--|--|--|--|--|--|--|--|--|---|---|---|
| < 1 0 > | R | F | I | D |   |   |   |   |   |   |  |  |  |  |  |  |  |  |  |   |   |   |
| C       | A | R | E | E | R | S | E | N | S | E |  |  |  |  |  |  |  |  |  | O | F | F |

(25) RFID carrier sense setting  
Enable/Disable the carrier sense test by using the [FEED] or [RESTART] key.

[PAUSE]

(26) Press the [PAUSE] key.

|         |   |   |   |   |   |  |  |  |  |  |  |  |  |  |  |  |  |  |  |   |   |   |   |
|---------|---|---|---|---|---|--|--|--|--|--|--|--|--|--|--|--|--|--|--|---|---|---|---|
| < 1 0 > | R | F | I | D |   |  |  |  |  |  |  |  |  |  |  |  |  |  |  |   |   |   |   |
| M       | O | D | U | L | E |  |  |  |  |  |  |  |  |  |  |  |  |  |  | N | O | N | E |

(27) RFID module type setting  
Select a type by using the [FEED] or [RESTART] key.

[PAUSE]

(28) Press the [PAUSE] key.

|         |   |   |   |   |   |   |   |  |  |  |  |  |  |  |  |  |  |  |  |  |  |  |  |
|---------|---|---|---|---|---|---|---|--|--|--|--|--|--|--|--|--|--|--|--|--|--|--|--|
| < 1 0 > | R | F | I | D |   |   |   |  |  |  |  |  |  |  |  |  |  |  |  |  |  |  |  |
| T       | A | G |   | N | O | N | E |  |  |  |  |  |  |  |  |  |  |  |  |  |  |  |  |

(29) RFID tag type setting  
Select a tag type by using the [FEED] or [RESTART] key.

[PAUSE]

(30) Press the [PAUSE] key.

|         |   |   |   |   |   |   |  |  |  |  |  |  |  |  |  |  |  |  |  |   |   |   |
|---------|---|---|---|---|---|---|--|--|--|--|--|--|--|--|--|--|--|--|--|---|---|---|
| < 1 0 > | R | F | I | D |   |   |  |  |  |  |  |  |  |  |  |  |  |  |  |   |   |   |
| E       | R | R |   | C | H | K |  |  |  |  |  |  |  |  |  |  |  |  |  | O | F | F |

(31) RFID error tag detection  
Enable/Disable the detection by using the [FEED] or [RESTART] key.

[PAUSE]

(32) Press the [PAUSE] key.

|         |   |   |   |   |  |   |   |   |   |   |  |  |  |  |  |  |  |  |  |  |  |   |
|---------|---|---|---|---|--|---|---|---|---|---|--|--|--|--|--|--|--|--|--|--|--|---|
| < 1 0 > | R | F | I | D |  |   |   |   |   |   |  |  |  |  |  |  |  |  |  |  |  |   |
| I       | S | S | U | E |  | R | E | T | R | Y |  |  |  |  |  |  |  |  |  |  |  | 3 |

(33) Maximum number of issue retries setting  
Set a value by using the [FEED] or [RESTART] key.

[PAUSE]

(34) Press the [PAUSE] key.

|   |   |   |   |   |   |   |   |   |  |  |  |  |  |  |  |  |  |  |   |
|---|---|---|---|---|---|---|---|---|--|--|--|--|--|--|--|--|--|--|---|
| < | 1 | 0 | > | R | F | I | D |   |  |  |  |  |  |  |  |  |  |  |   |
| R | C | Y | C | L | E | C | N | T |  |  |  |  |  |  |  |  |  |  | 5 |

[PAUSE]

|   |   |   |   |   |   |   |   |   |  |  |  |  |  |  |  |  |  |   |    |
|---|---|---|---|---|---|---|---|---|--|--|--|--|--|--|--|--|--|---|----|
| < | 1 | 0 | > | R | F | I | D |   |  |  |  |  |  |  |  |  |  |   |    |
| R | C | Y | C | L | E | T | I | M |  |  |  |  |  |  |  |  |  | 4 | .0 |

[PAUSE]

|   |   |   |   |   |   |   |   |   |  |  |  |  |  |  |  |  |  |  |   |
|---|---|---|---|---|---|---|---|---|--|--|--|--|--|--|--|--|--|--|---|
| < | 1 | 0 | > | R | F | I | D |   |  |  |  |  |  |  |  |  |  |  |   |
| W | C | Y | C | L | E | C | N | T |  |  |  |  |  |  |  |  |  |  | 5 |

[PAUSE]

|   |   |   |   |   |   |   |   |   |  |  |  |  |  |  |  |  |  |   |    |
|---|---|---|---|---|---|---|---|---|--|--|--|--|--|--|--|--|--|---|----|
| < | 1 | 0 | > | R | F | I | D |   |  |  |  |  |  |  |  |  |  |   |    |
| W | C | Y | C | L | E | T | I | M |  |  |  |  |  |  |  |  |  | 2 | .0 |

[PAUSE]

|   |   |   |   |   |   |   |   |  |  |  |  |  |  |  |  |  |  |   |    |
|---|---|---|---|---|---|---|---|--|--|--|--|--|--|--|--|--|--|---|----|
| < | 1 | 0 | > | R | F | I | D |  |  |  |  |  |  |  |  |  |  |   |    |
| A | D | J | R | E | T | R | Y |  |  |  |  |  |  |  |  |  |  | + | 00 |

[PAUSE]

|   |   |   |   |   |   |   |   |   |   |  |  |  |  |  |  |  |  |   |   |
|---|---|---|---|---|---|---|---|---|---|--|--|--|--|--|--|--|--|---|---|
| < | 1 | 0 | > | R | F | I | D |   |   |  |  |  |  |  |  |  |  |   |   |
| P | O | W | E | R | L | E | V | E | L |  |  |  |  |  |  |  |  | 1 | 8 |

[PAUSE]

|   |   |   |   |   |   |   |   |   |   |   |   |  |  |  |  |  |  |  |   |
|---|---|---|---|---|---|---|---|---|---|---|---|--|--|--|--|--|--|--|---|
| < | 1 | 0 | > | R | F | I | D |   |   |   |   |  |  |  |  |  |  |  |   |
| A | G | C | T | H | R | E | S | H | O | L | D |  |  |  |  |  |  |  | 0 |

[PAUSE]

|   |   |   |   |   |   |   |   |   |   |   |   |   |  |  |  |  |  |  |  |
|---|---|---|---|---|---|---|---|---|---|---|---|---|--|--|--|--|--|--|--|
| < | 1 | 0 | > | R | F | I | D |   |   |   |   |   |  |  |  |  |  |  |  |
| R | F | C | H | A | N | N | E | L | A | U | T | O |  |  |  |  |  |  |  |

[PAUSE]

|   |   |   |   |   |   |   |   |  |  |  |  |  |  |  |  |  |  |  |   |
|---|---|---|---|---|---|---|---|--|--|--|--|--|--|--|--|--|--|--|---|
| < | 1 | 0 | > | R | F | I | D |  |  |  |  |  |  |  |  |  |  |  |   |
| Q | V | A | L | U | E |   |   |  |  |  |  |  |  |  |  |  |  |  | 2 |

[PAUSE]

(35) Maximum number of read retries setting  
Set a value by using the [FEED] or [RESTART] key.

(36) Press the [PAUSE] key.

(37) Read retry time-out setting  
Set a value by using the [FEED] or [RESTART] key.

(38) Press the [PAUSE] key.

(39) Maximum number of write retries setting  
Set a value by using the [FEED] or [RESTART] key.

(40) Press the [PAUSE] key.

(41) Write retry time-out setting  
Set a value by using the [FEED] or [RESTART] key.

(42) Press the [PAUSE] key.

(43) RFID adjustment for retry  
Set a value by using the [FEED] or [RESTART] key.

(44) Press the [PAUSE] key.

(45) Radio output power level setting  
Set a value by using the [FEED] or [RESTART] key.

(46) Press the [PAUSE] key.

(47) AGC threshold setting  
Set a value by using the [FEED] or [RESTART] key.

(48) Press the [PAUSE] key.

(49) RFID channel setting  
This menu is not available to the B-SA704-RFID-U2-EU-R.

(50) Press the [PAUSE] key.

(51) Q value setting  
Set a value by using the [FEED] or [RESTART] key.

(52) Press the [PAUSE] key.

|   |   |   |   |   |   |   |   |  |  |  |  |  |  |  |  |   |   |
|---|---|---|---|---|---|---|---|--|--|--|--|--|--|--|--|---|---|
| < | 1 | 0 | > | R | F | I | D |  |  |  |  |  |  |  |  |   |   |
| W | T | A | G | C |   |   |   |  |  |  |  |  |  |  |  | 1 | 1 |

[PAUSE]

|   |   |   |   |   |   |   |   |  |  |  |  |  |  |  |  |   |   |
|---|---|---|---|---|---|---|---|--|--|--|--|--|--|--|--|---|---|
| < | 1 | 0 | > | R | F | I | D |  |  |  |  |  |  |  |  |   |   |
| W | T | M | I | N | A | G | C |  |  |  |  |  |  |  |  | 1 | 1 |

[PAUSE]

|   |   |   |   |   |   |   |   |  |  |  |  |  |  |  |  |  |  |
|---|---|---|---|---|---|---|---|--|--|--|--|--|--|--|--|--|--|
| < | 1 | 0 | > | R | F | I | D |  |  |  |  |  |  |  |  |  |  |
|   |   |   |   |   |   |   |   |  |  |  |  |  |  |  |  |  |  |

(53) AGC threshold for data write  
Set a value by using the [FEED] or [RESTART] key.

(54) Press the [PAUSE] key.

(55) AGC threshold lower limit for retry  
Set a value by using the [FEED] or [RESTART] key.

(56) Press the [PAUSE] key.

(57) RFID setting menu display

### 6.11.2 Details of RFID Setting

#### (1) RFID read test

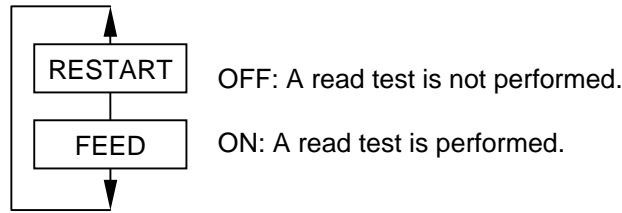

OFF: A read test is not performed.

ON: A read test is performed.

OFF: A read test is not performed.

ON: The printer enters read test mode, and a read test is performed each time the [PAUSE] key is pressed. The read data on the tag is displayed on the LCD. When the tag cannot be read, "RFID TIMEOUT" or "RFID READ ERROR" is displayed.

If the type of the tag to be read and one selected by the RFID tag type selection menu do not match, an RFID tag read error will result. Make sure the RFID tag type has been selected before the read test is started.

Read data is displayed in hex. value on the 16-digit x 2-line LCD. The data to be displayed is the EPC code in the EPC area of a tag.

|                  |
|------------------|
| 1234567890123456 |
| 6543210987654321 |

When the RFID tag contains 16 digits or more data, the first 16 digits are displayed. When data volume is less than 16 digits, the vacant digits will be filled with spaces.

#### (2) RFID carrier sense setting (Not available to the B-SA704-RFID-U2-EU-R.)

#### (3) RFID module type

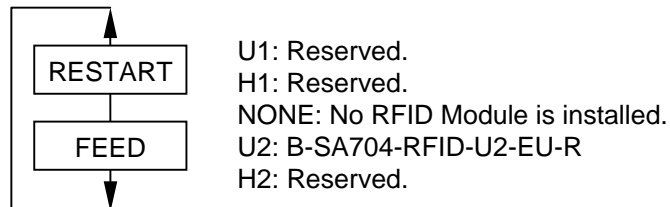

U1: Reserved.

H1: Reserved.

NONE: No RFID Module is installed.

U2: B-SA704-RFID-U2-EU-R

H2: Reserved.

NONE: No RFID kits are installed.

U1: Reserved.

H1: Reserved.

H2: Reserved.

U2: B-SA704-RFID-U2-EU-R

NOTE: The module type changed by using this menu becomes effective after the power is turned off and back to on.

(4) RFID tag type  
Module type: U2

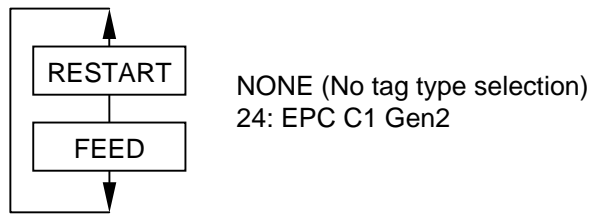

NOTE:

1. The tag type changed by using this menu becomes effective after the power is turned off and back to on.
2. Only tag type options which are available to the selected module type are displayed.

(5) RFID error tag detection

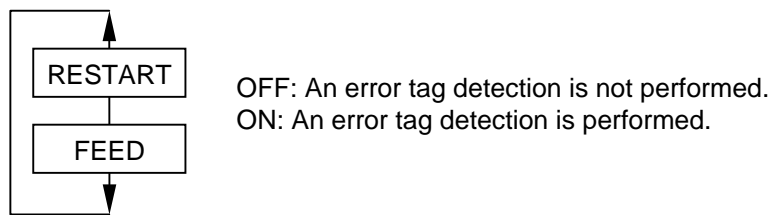

ON: An error tag detection is performed. A tag is read before writing data to it, and the data is written to the tag only when the tag's header data is "A5A5".

OFF: An error tag detection is not performed. A tag is read before writing data to it, but the data is always written to the tag regardless of the tag's header data.

(6) Maximum number of issue retries

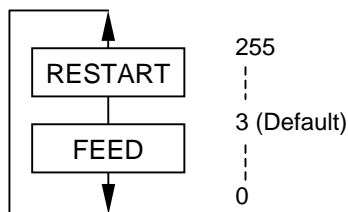

0 to 255

Set a maximum number of retries to issue an RFID tag.

When issuing an RFID tag failed, the printer prints the error pattern, and retries to issue the tag for up to specified number of times. If the printer does not succeed even after having retried for the max. times, the printer stops, resulting in an error.

(7) Maximum number of read retries

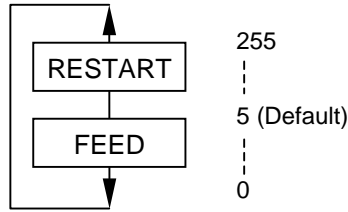

0 to 255

Set a maximum number of retries to read an RFID tag.

The printer retries to read the data in an RFID tag for up to specified number of times. If the timeout period expired before the max. number of retries have been done, the printer stops the retries at the time.

Whenever the printer writes data onto an RFID tag, the tag is read first. The max. number of retries set by this parameter becomes also effective in this pre-read.

(8) Read retry time-out

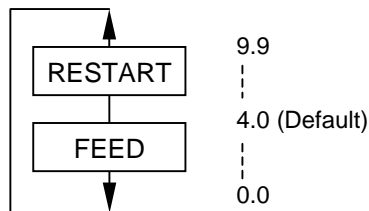

0.0 to 9.9 (0.0 seconds to 9.9 seconds)

Set the timeout period during which RFID tag read retries are allowed. If the printer has retried for the max. number of times within the RFID read retry timeout, the printer stops the retries at the time.

Whenever the printer writes data onto an RFID tag, the tag is read first. The read retry timeout set by this parameter becomes also effective in this pre-read

(9) Maximum number of write retries

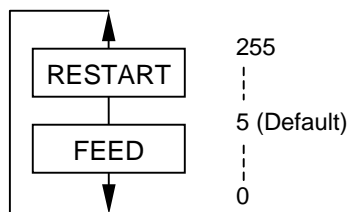

0 to 255

Set the maximum number of retries to write data onto an RFID tag.

The printer retries to write data onto an RFID tag for up to specified number of times. If the timeout period expired before the max. number of retries have been done, the printer stops the retries at the time.

(10) Write retry time-out

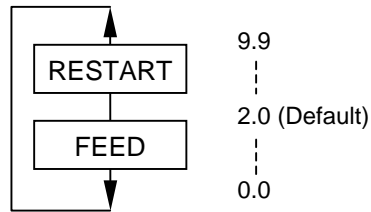

0.0 to 9.9 (0.0 seconds to 9.9 seconds)

Set the timeout period during which RFID tag write retries are allowed.

If the printer has retried for the max. number of times within the RFID write retry timeout, the printer stops the retries at the time.

(11) RFID adjustment for retry

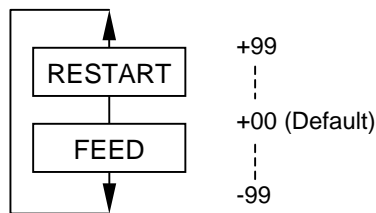

-99 mm to +99 mm

+: Reverse feed      -: Forward feed

Set a value to feed an RFID tag.

If writing data on a tag failed, the printer feeds the RFID tag forward or backward for specified length in order to retry writing data. When "0" is set for this parameter, this function and a retry are not performed.

Only the value of -3mm or less or +3mm or more becomes effective.

(12) Radio output power level: When the B-SA704-RFID-U2-EU-R is used.

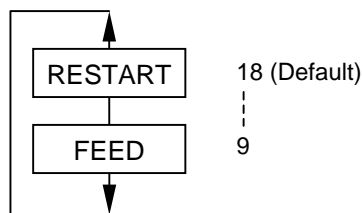

9 to 18

Set the power level of the RFID module.

When the value is "9", the power is the weakest, and when "18", the power is the strongest.

The factory default setting is "18". The optimum value differs depending on the tag types.

Usually, it is not necessary to change this value but changing the value may be able to improve the read/write rate.

(13) AGC threshold

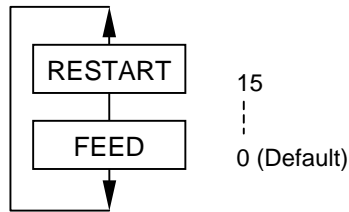

0 to 15

When the obtained gain of an RFID tag is lower than the AGC threshold, the tag is considered as an error tag even if a data write succeeds.

When the AGC threshold is set to "0", all tags are writable.

When set to "8", for example, only tags with the AGC threshold level of 9 or greater are writable. The optimum value is different depending on the tag types. The factory default is 0.

(14) RFID channel setting (Not available to the B-SA704-RFID-U2-EU-R.)

(15) Q value

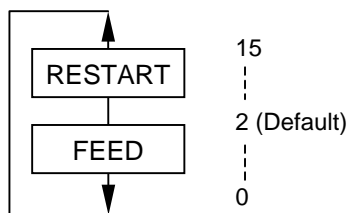

0 to 15

In the case multiple RFID tags are read at the same time, this menu is useful to pinpoint a target tag.

Set the Q value to "1" or greater (2 is recommended). Q value "0" causes the tags to interfere with each other and disables proper data write.

When a Q value is set, set an AGC threshold for data write and an AGC threshold lower limit for retry, also. Setting all these values enable writing data to a tag placed just above the antenna.

The factory default is 2.



(16) AGC threshold for data write

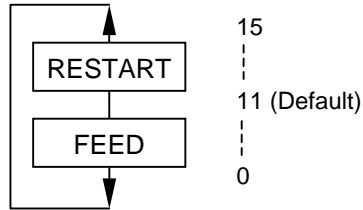

0 to 15

When the Q value is set to 1 or greater, the AGC threshold for data write becomes effective. When the obtained gain of an RFID tag is lower than the AGC threshold for data write, a data write operation is not performed. In other words, setting an AGC threshold for data write enables writing data only to a tag placed just above the antenna.

Supposing that the gain of a tag just above the antenna is 14 and that of a tag off the antenna is 7, setting the threshold to 11 (a value between 8 and 14) enables the printer to write data only to the tag just above the antenna.

When the threshold is set to 0, a data write operation is performed regardless of the gain of a tag.

Both of the AGC threshold and the AGC threshold for data write are used to determine whether a tag is defective or not, but the timing of a gain measurement is different. In the case of the AGC threshold, this is performed after data is written to a tag.

On the contrary, when the AGC threshold for data write is effective a measurement is performed before data is written. And if a gain value is lower than the threshold, a data write operation is not performed.

The optimum value differs depending on the tag type.

(17) AGC threshold lower limit for retry

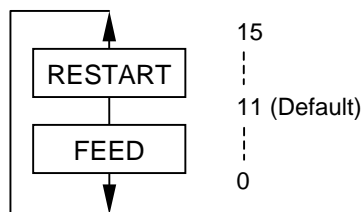

0 to 15

When the Q value is set to 1 or greater, the AGC threshold lower limit for retry becomes effective.

Even if a tag's gain is lower than the AGC threshold for data write, a data write to the tag may be successful in a retry if the gain is greater than the lower limit. For a retry, the printer lowers the threshold to the highest gain of the tag if it is greater than the lower limit or to the lower limit if it is greater than the highest gain of the tag.

Example 1

AGC threshold for data write: 11

Lower limit for retry: 9

Detected tag's gain: 10

As the gain of the tag is lower than the threshold, a data write operation is not performed for this tag at the first try. However, the gain is greater than the lower limit.

Then the printer retries to write data to this tag according to a new AGC threshold of 10.

In this case, a retry of a data write will mostly succeed because the detected tag's gain is greater than the new threshold. (However, the success rate is not 100% because a gain of a tag is not always the same.)

### Example 2

AGC threshold for data write: 11

Lower limit for retry: 9

Detected tag's gain: 8

As the gain of the tag is lower than the threshold, a data write operation is not performed for this tag at the first try. Also, the gain is lower than the lower limit.

Then the printer retries to write data to this tag according to a new AGC threshold of 9.

In this case, a retry of data write will mostly fail because the detected tag's gain is lower than the new threshold. (However, the error rate is not 100% because a gain of a tag is not always the same.)

When the same value is set to the AGC threshold for data write and the AGC threshold lower limit for retry, respectively, the threshold will not be changed for a retry.

The optimum value differs depending on the tag type.

## 7. DOWNLOAD MODE

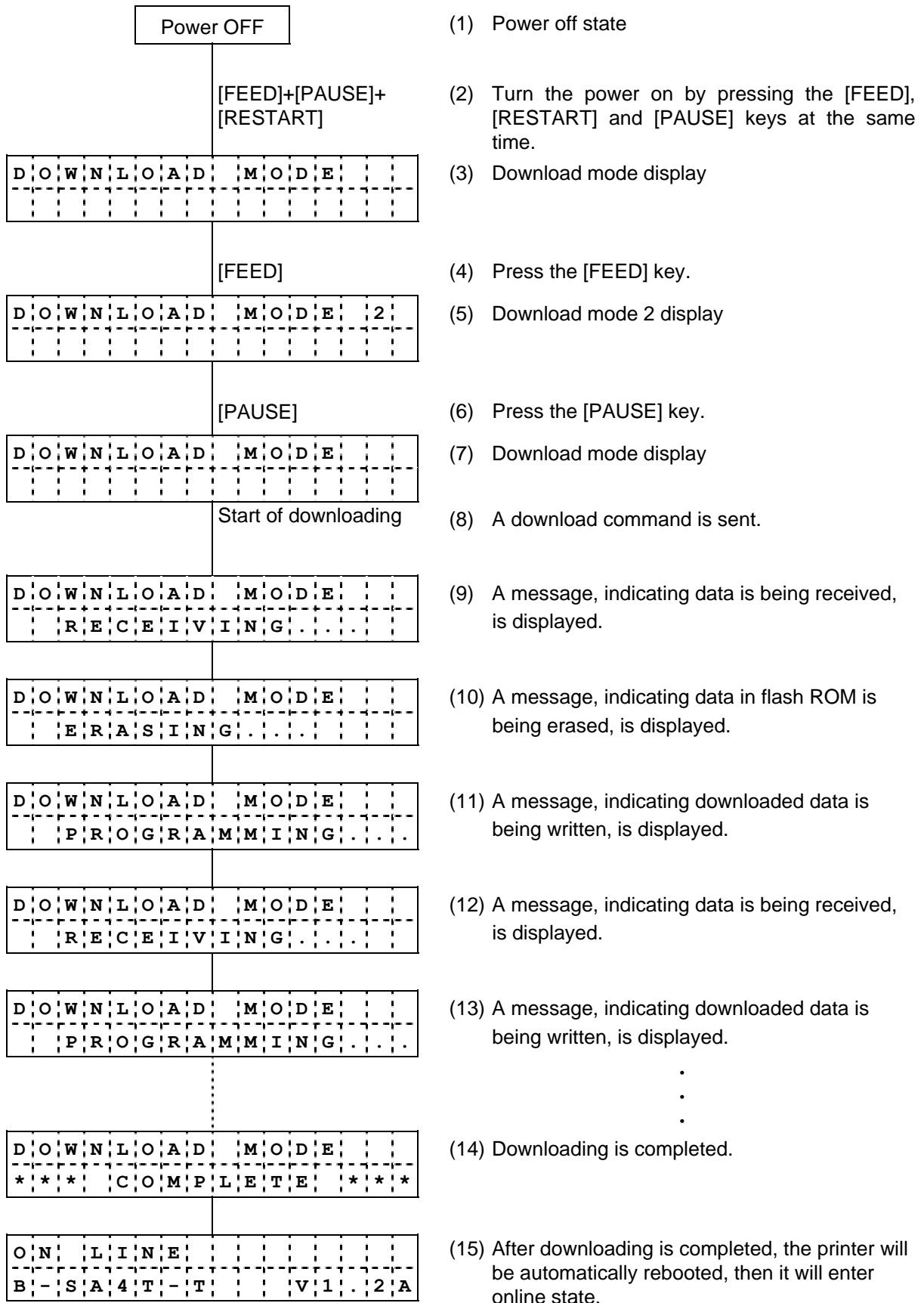

**Note:** If the LCD message does not change from “\*\*\* COMPLETE \*\*\*” to “ON LINE”, the firmware for the B-SX4T or B-SX5T could have been downloaded by mistake.

When the power is turned on while the [FEED], [RESTART], and [PAUSE] keys are pressed at the same time, the printer enters download mode.

In download mode, only commands concerning downloading are available.

The printer keys function only to change a mode between "DOWNLOAD MODE" and "DOWNLOAD MODE 2". A Centronics ACK-BUSY timing differs between "DOWNLOAD MODE" and "DOWNLOAD MODE 2". When downloading is not performed properly in "DOWNLOAD MODE", it may be performed properly in "DOWNLOAD MODE 2".

Either of the following two types of BUSY/ACK timing is available:

(1) DOWNLOAD MODE (Default)

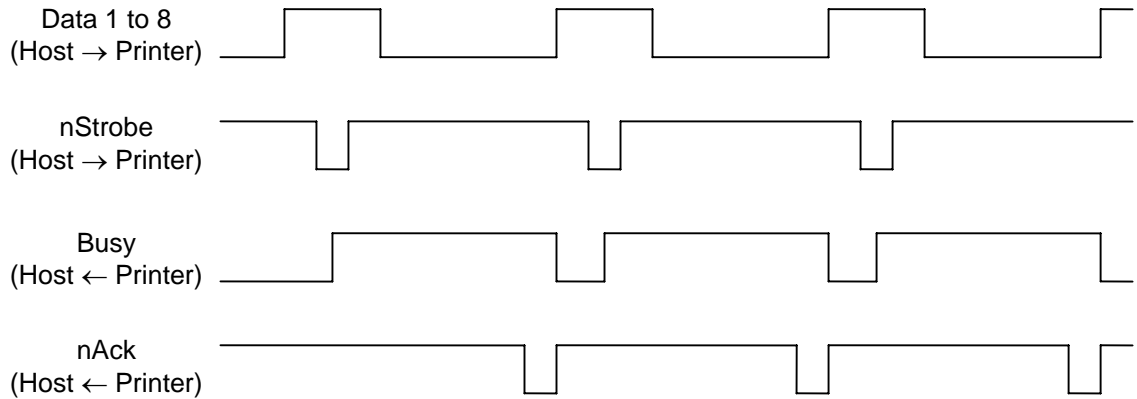

(2) DOWNLOAD MODE 2

